

# WORKING WITH BEAVER FOR BETTER HABITAT NATURALLY!

WORKING WITH LANDOWNERS, TEACHING ABOUT THE ECOLOGICAL BENEFITS OF BEAVER,  
BUILDING FLOW DEVICES, LIVE-TRAPPING AND RELOCATING, AND MORE

BY **SHERRI TIPPIE**  
DIRECTOR OF WILDLIFE 2000

## Acknowledgments

I could have never accomplished what I have without the following people both helping and guiding me:

Jerry Mallett, President Adventure Travel Society, Western Representative Wilderness Society, and former President of United Sportsmen. Cleveland Amory, Fund for Animals, who bought me my first two Hancock live beaver traps. Bruce Smith, Former Bureau of Land Management in Wyoming, currently U.S. Forest Service, in Idaho. Former Directors of Colorado Division of Wildlife Jim Ruch (1983-1988), Perry Olson (1988-1996). Jim Bennett, Aquatic Nongame Specialist, Colorado Division of Wildlife. Dave Hoart, District Wildlife Manager, Colorado Division of Wildlife. Jim Lipscomb, Retired State Wildlife Manager, Colorado Division of Wildlife. Jim Bennett, Retired Fisheries Biologist Colorado Division of Wildlife. Dr. John Hadidian, Humane Society of the United States. Skip Lisle, Beaver Deceivers International. Lew Pence, Pence Farms, Idaho. Kate Willer who never seems to tire of my frantic calls and is always ready with good advice. Gorrell Iron Works who since 1985 has kept my live traps in working order, and my cages secure. All the volunteers who have helped me pull beaver out of creeks and rivers! A new light in my life: Mary O'Brien, Grand Canyon Trust for her huge support, patience, strength and - making me look smart. Liz Bell, of the Wilburforce Foundation for tracking down funds for this project from which beaver, landowners, habitat and loads of wildlife will all benefit.. Lastly, my Mother, Polly Wilson, who with her love and support, allowed me to continue having the most "important" fun I can have in my life, catching and moving beaver, and telling people all about beaver!

## Table of Contents

Acknowledgements by Sherri Tippie .....	2
Introduction .....	3
by Mary O'Brien	
Sherri Tippie: How a Humble Rodent Can Change a Life .....	4
I. Beaver: Our Water Partner .....	6
II. Let's Do Lunch .....	8
How to Protect Trees from Beaver	
III. Go With the Flow.....	9
Beaver Deceivers, Double Filter Systems & Castor Masters	
IV. When Beaver Are Plugging a Culvert (1) .....	10
Building a Beaver Deceiver	
V. When Beaver Are Plugging a Culvert (2) .....	15
Building a Double Filter System	
VI. When a Beaver Pond is Flooding Property .....	18
Building a Castor Master	
VII. Living With Beaver .....	21
Changing Minds of Landowners	
VIII. When Beaver Don't Get to Stay Where They Are .....	23
Live-trapping and Relocating Beaver	
IX. Mistakes to Avoid .....	29
X. Conclusion.....	30

Introduction  
by Mary O'Brien  
Grand Canyon Trust

There are many reasons to encourage the return of beaver to their historical creeks and streams, including increased stream functioning, enhanced biodiversity, adaptation to climate change, and wetlands creation.

The good news is that beaver bring us and the world big benefits. The bad news is that sometimes we're not prepared to accommodate beaver's great works. And then the good news is that we can **learn** to accommodate beaver's great works. Hence this publication, *Working With Beaver for Better Habitat Naturally*, written by veteran Colorado livetrapper Sherri Tippie.

Having trapped more than a thousand beavers in the last quarter century, while losing only two adult beavers in the process (to a flash flood), Tippie might be expected to write first and foremost about livetrapping. After all, that was her initial, and life-transforming, introduction to beaver.

But the reader of *Working With Beaver for Better Habitat Naturally* will have to wait until Chapter VIII for livetrapping advice, because Tippie's primary information is designed to assist living with dam-building beaver where beaver want to build dams, so that we gain the greatest benefit possible from their engineering efforts.

In *Working With Beaver for Better Habitat Naturally*, livetrapping comes to the fore only when we're unable or unwilling to live with beaver, for instance when we've built an irrigation ditch and a beaver family wants to turn it into a more complex hydrological system; or when we've built infrastructure - a road or a house, for instance - too close to a creek to accommodate beaver - even with a Castor Master (Chapter VII).

Hence, Chapters II-VI focus on how we can leave beaver right where they are, and only Chapter VIII involves moving beaver to where they will be accepted.

At base, then, this publication teaches us how to respect and live with beaver. But if we insist on moving beaver, Tippie provides us, out of her 25 years of livetrapping experience, information on how to do so with care.

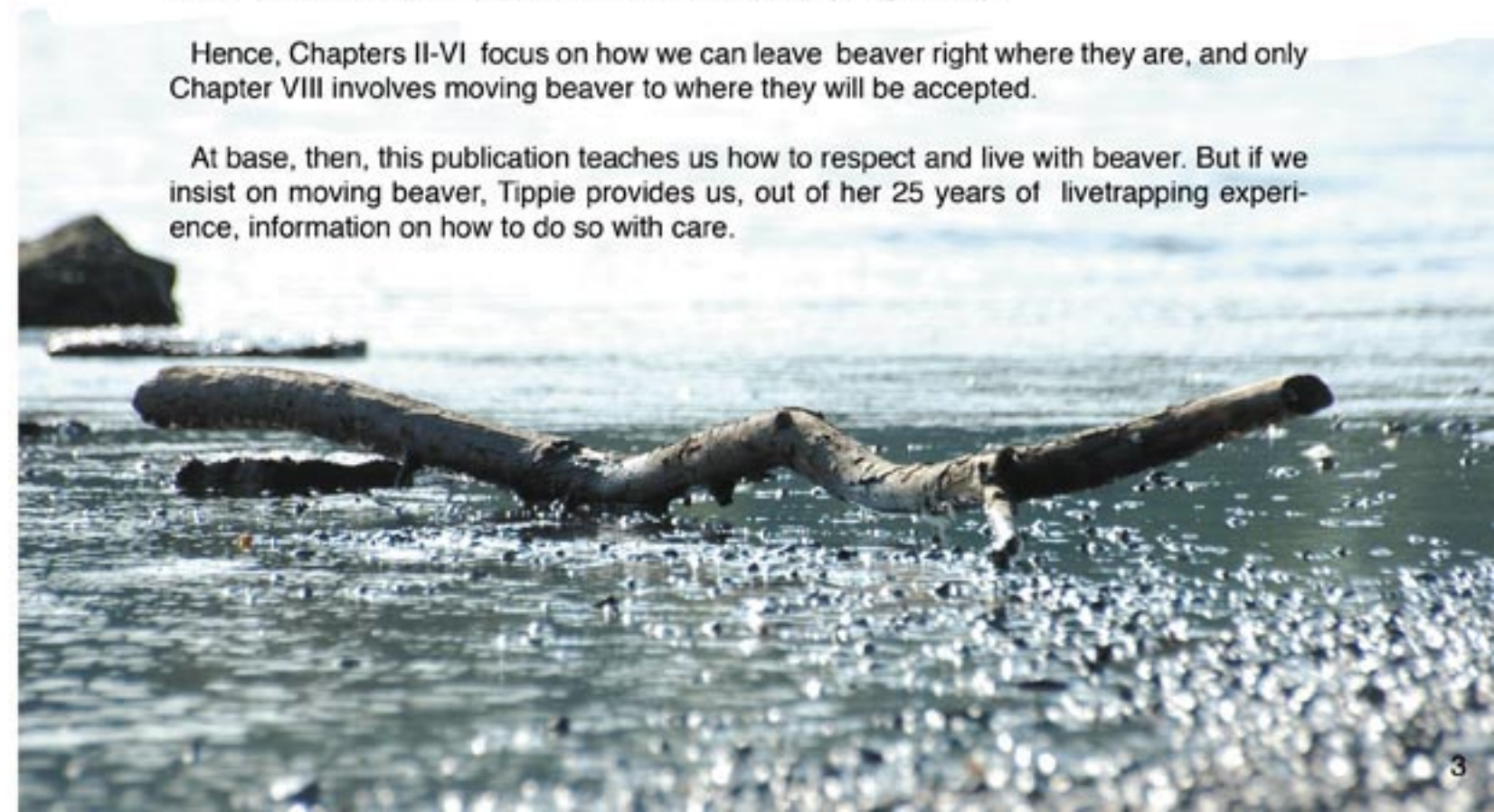

Live-trapping and relocating beaver changed my life forever!

Have you ever heard the saying, "Sometimes the best things that happen to us, happen by accident?" That's how I started live-trapping and relocating beaver! Now it's true, I've always loved wildlife. My father loved to hunt, and taught me at an early age to appreciate wildlife. For myself, however, I've never developed a taste for hunting.

I just wanted to make a difference for our wildlife. I've seen too many people moving to Colorado, where I live, who think they can pick and choose what wildlife they will and won't live with. They don't like marmots because they eat their flowers. Or they don't like bear because they get into their garbage! (Which people irresponsibly leave out, I might add.) Too often people don't realize that it's all one big circle of life: everything is interrelated and inter-connected. For way too long, many in the public have been brainwashed to the point that whenever they have a problem with any wildlife, they respond like Pavlov's dog: they automatically think of "killing" as the solution.

Anyway...when I first decided to get involved with wildlife issues, I was focused on coyotes and mountain lion. For instance, in 1981 I testified before the EPA against the reintroduction of the poison 1080 that kills coyotes, and is so horribly cruel and indiscriminate. At that point, beaver hadn't entered my mind. Oh, I knew they had flat tails and made dams, but that's it. Then one afternoon in 1985, while I was scrubbing my floor with the TV on, a story caught my attention. The city of Aurora had hired a trapper to kill beaver who were taking down trees on a city golf course. It even showed the trapper setting one of his traps in the water near a tree. Ironically, he was wearing a black hat. The newscaster explained, "The Colorado Division of Wildlife says the beaver have to be killed because there is no place to put them."

At first I thought, Oh NO! These beaver are going to be killed for doing what beaver are supposed to do. The thought of it really angered me. So I decided to try and find a place where the beaver could be moved. The first person I called, then Director of Rocky Mountain National Park David Stevens, told me he had also seen the story on the news. We discussed it, and he said Aurora's beaver could be relocated into the Park. I was so excited and relieved I couldn't wait to call the Division of Wildlife! The man I

called was one of the Area Managers at the Colorado Division of Wildlife whom I knew. I told him I found a place for Aurora's beaver. He asked me where? When I said Rocky Mountain National Park, he complained, "Do you know how much money that will cost?"

I said, "What? \$5.00 for gas? I'll do it!"

He didn't object. So, I called Aurora to tell them the good news, which they actually felt was good news, because they had been getting loads of angry calls from people who, like me, didn't want the beaver to be killed. Aurora was more than happy to give me the phone number of the trapper. Right after we hung up, no doubt because of all the horrible PR Aurora had received, the city called the press to let them know there had been a change of plans for the beaver in Aurora.

I called the trapper and told him about my plan: he could live-trap the beaver instead of kill-trapping them, and I would then relocate them to Rocky Mountain National Park. He responded that every time he had tried to live-trap beaver, they had drowned. I told him that I knew they could be livetrapped, because I had seen photos in *National Geographic!*

So, I simply said, "That's OK, I'll do it."

I really don't know why I said that. I guess at that point, I just had a lot of energy and emotion invested in these beaver. Not long after I hung up talking with the trapper, I started getting calls from the media. I mean ALL the media. Every TV station and newspaper was calling me! I thought to myself, "What have I gotten into?!"

I found out from a Fisheries Biologist at the Colorado Division of Wildlife, that the Division had the live-traps I needed. However, I also heard there were some individuals at the

Division who were very unhappy with me and my plan to save Aurora's beaver. So when I went to borrow the live-traps from the Division, I took a newspaper guy with me for added public relations pressure. And it worked! Because when I asked the man at the Colorado Division of Wildlife if I could borrow a couple of live-traps, he simply said, "Just a minute," and walked off. When he came back, he was carrying two Hancock live-beaver traps.

I couldn't see the live-traps very well because they were in boxes. All I could tell was they were huge! Again I thought, "What have I gotten myself into?"

I looked at the guy from the Division, and trying not to

show fear, I said, "You want to run through setting one of these things with me?"

He put his hand on my shoulder, looked down at me and said, "Oh... you'll figure it out!"

When I first got those Hancock traps home and took them out of the boxes in the front yard, I'm embarrassed to say this, but I cried. The traps were so big, and so intimidatng! I was getting called by the media, I had animals depending on me, but I didn't have a clue what I was doing.

Thinking about the beaver, however, I pulled myself together. I found the instructions for the traps in the box and started reading. Then, step by step, I figured out how to set the Hancock livetraps. A little side note: I'm really grateful the man at the Colorado Division of Wildlife chose not to show me how to set the Hancock live beaver trap. It turns out, I've never

seen anyone at a wildlife agency set that trap correctly. They no doubt throw away the instructions.

The first night live-trapping, I caught two beaver. I don't know when I've had more fun in my life! I got wet and muddy, and I was catching animals. I was in Heaven! Looking back, I truly believe the only reason the Colorado Division of Wildlife didn't literally stop me from live-trapping and relocating those beaver was because they thought I was going to catch a few beaver, get my fill, and disappear into the woodwork. Boy, were they wrong!

Remember I said I didn't know anything about beaver? Well, when I started catching beaver, I was probably handling them in a way no biologist ever would. But I'm not a biologist, I'm a hair dresser! And remember, I said I love wildlife. Well, I do, and I handle the beaver like I love them. What's so neat is, for some reason, they responded to me. I was picking up 35- and 40-lb beaver right out of the live-trap and carrying them around. They were amazing!

So, I started reading everything I could get my hands on about beaver. What I learned was that we really shouldn't be relocating beaver at all. We should be learning to coexist with them, because they are an important species, a keystone species.

Now when people call me saying they have beaver they want relocated, the first thing I ask them is, "What are the beaver doing that's causing you a problem?" Basically, I try to solve their problem so the beaver can stay in the habitat where they belong. If someone doesn't care about the beaver, or try to understand what they need to survive, or doesn't know anything about the beaver, other than they don't like them, and they try to come up with a conflict solution, I promise you, they're going to fail!

The amazing thing is, when people find out even a little bit about beaver, when they understand even just a little bit, they often decide to coexist with them. I believe it's my job to enlighten those people. Besides, it's fun! And, it makes the world a better place.

The thing is... and this is how you know I'm sincere: my organization, Wildlife 2000, would make more money live-trapping and relocating beaver than we do educating people about conflict solutions and flow devices, or even installing flow devices. But for me, it's the right way of doing things. Because in the end, by doing things the right way, all things benefit: the land, the wildlife, the landowner, and even me!

Speaking about flow devices, in 1990 I met Skip Lisle of Beaver Deceivers International, which is

## How a Humble Rodent Can Change a Life

by Sherri Tippie



## How a Humble Rodent Can Change a Life by Sherri Tippie (continued)

located in Vermont. Skip makes the only flow devices Wildlife 2000 will endorse. Why? Because Skip's flow devices not only work, they take the needs of the beaver into consideration. This makes them the best! Skip has developed state-of-the-art flow devices: The Beaver Deceiver, the Castor Master, and the Double Filter System. You have no idea how many times I've had someone tell me they've tried pipes, fencing, or whatever, as a solution to beaver conflicts and they just don't work. I tell them, "NO, you just didn't do it right."

I've also seen flow devices that are ugly. They literally look like someone dumped construction debris into the water near a culvert or a beaver dam. People always mess up when they try to come up with a conflict solution without knowing about the beaver, other than they don't like them. Skip's flow devices are always well constructed, and this may sound strange, but they are beautiful. Best of all, they last, they work, and the price is more than right. Call Skip at (802) 843-1017, or call me, Tippie, at (303) 935-4995.

In my heart, I believe we are in this together - so if you have questions or comments, call me.



flow devices  
can be beautiful!

## Part One

## The Beaver Trail



historical  
beaver! ↗



Before Europeans emigrated to North America, it's estimated there were between 60 to 400 million beaver; roughly the equivalent of 10-60 beaver per mile of stream and river! They lived from the Arctic tundra to the northern part of Mexico. The only places you didn't find beaver were in arid Southwest deserts and Florida's tropical tip.

It's interesting to note that beaver back then were a variety of colors: there were very dark beaver; along Lake Superior and Hudson Bay, the Sioux called them beaver-black. Pure white beaver, considered sacred by Indians, were commonly found at Little Slave Lake in Yellowstone. There were also beaver whose fur was the color of chocolate, silver, red and blonde. By the early 1900's, after beaver had been kill-trapped for their fur practically to the edge of extinction, most color variations were gone. The beaver you see today are generally a warm shade of brown.

When it became obvious that the removal of beaver caused the quantity and quality of riparian habitat to decline, many western states not only started protecting beaver, they started live-trapping and relocating beaver back into the exploited areas to improve and restore degrading habitats. Unfortunately, it's estimated the West still has only 10% of the beaver it had historically.

### Some Vital Statistics

The American beaver, *Castor Canadensis*, is the largest rodent in North America. Beaver continue to grow and put on weight throughout their lives, although as they age, their growth rate slows down. Their average weight is between 40 and 50 pounds. The largest beaver on record was captured in Wyoming, in 1938, and weighed 115 lbs. Beaver can live 10 - 20 years.

The most distinctive physical feature of the beaver is their paddle-shaped, scaly-patterned, dorsally flat tail. They use their tail like a rudder on a boat

to guide them through the water; for balance when they're sitting up and chewing on trees; and to slap the water sounding alarm. When they feel threatened, they will dive for protection and can hold their breath for up to 15 minutes. Beaver are generally slow and clumsy on land, but they glide with ease through the water.

Even though beaver have small eyes and are nearsighted, they're quick to notice movement. When they dive, transparent lids cover their eyes, which enables them to keep their eyes open and see underwater. Their ears are small too, but their sense of hearing is amazing, and alerts them to the sound of danger. When they swim underwater, they fold their ears back to keep out water. Their keen sense of smell helps beaver find and select food. It also helps them identify family members and detect predators.

Beaver have four prominent bright orange incisors: two on the top, and two on the bottom. Because these incisors never stop growing, the beaver keep them filed down by chewing on trees or grinding their teeth together. Conveniently, they have a flap that closes behind their incisors; this enables them to keep water out of their mouth while carrying branches and food underwater. They use their molars, whose surfaces resemble ribbon candy, to grind their food so it can be digested.

Beaver have large webbed hind feet that are great for swimming. The second toe, on the inside of their webbed foot, has a double claw, which they use like a comb when they're grooming. The double claw is also used to distribute a waterproofing oil that comes from a gland located on the belly, near the base of the tail. Beaver are almost as dexterous with their hands as we are with ours; one of their outside



## Family Values

It's believed beaver mate for life and are monogamous, so their families are considered relatively stable. However, a beaver who has lost its mate may seek another. It's also a "matriarchal" family, with the female directing the dam and lodge building. And, I've read that the female is most often the first out of the lodge in the evening.

Beaver reach sexual maturity at one and a half to two years old. They have one litter a year and, in Colorado, beaver mate in January to February. Gestation is about 105 days, with kits being born sometime in May. When kits are born, they weigh a few ounces, their eyes are open, and they are fully furred. The average litter size is two to four kits, but can reach six if the food availability is good. Kits nurse about six weeks, however four to 14 days after the kits are born, they start eating tender shoots and leaves, brought to them most often by their father! Once kits are weaned, all family members take part in raising them. Kits stay with their parents for two years before they leave home to find a mate, and create a habitat of their own.

## Food

Beaver are vegetarians. In Colorado, beaver will eat a variety of trees including alder, apple, birch, and box elder, but when available, they seem to prefer willow, as well as aspen and cottonwood, all three of which are members of the fast-growing willow family. As beaver prune cottonwood, aspen, or willow with their sharp incisors, plant hormones kick in, sending a message to the root system, triggering profuse new growth the following Spring.

Along with the leaves, beaver eat the cambium (green living layer) between the bark and the wood of the tree. Beaver use the branches to build their homes, called lodges, and dams that impound water, creating ponds and wetlands.

## Predators

Any meat-eating animal (carnivore) big enough to kill a beaver, will try to. That includes bear, mountain lions, wolves, coyotes, lynx and dogs. Eagles will take kits, and otter have been known to swim right into the lodge after small beaver. As with most wildlife, however, the #1 predator beaver have to be concerned about is HUMANS.

## What's Not To Love?

Beaver are a keystone species, meaning they create and maintain a healthy and productive aquatic and riparian system for a great number of wildlife species, as well as humans. For example, beaver create ponds and wetlands, heal incised creeks, and trap sediment, improving water quality. It's estimated that 85% of wildlife in the West, at some point in their lives, depend on the very riparian and aquatic habitats that beaver create.

But wait. . . that's not all! A network of beaver dams can help reduce high flows and downstream flooding. And when beaver are abundant, they can actually help make our forests fire-resistant. Their leaky dams raise the water table, slow runoff, and create wetlands and large riparian areas that act as natural firebreaks. Also, the water beaver store in their ponds by building dams is just the water you can see. What you can't see is all the water held beneath the pond, in the bank, and below ground downstream of a dam. This water eventually seeps back into the creek downstream, creating greater and cooler water yields later in the summer.

Water quality is also improved when the rich soil/sediment that would otherwise leave a reach and wash downstream, instead settles to the bottom of the pond, and is trapped behind the dam. This, in turn, causes the water table to rise and spread out over the land, which helps a variety and abundance of plant life to flourish. The term "biodiversity" is used to describe this valuable variety.

Some hydrologists consider the extirpation of beaver to be this country's greatest environmental disaster!

## Nuisance or Opportunity - It's All Perception!

The fact is. . . you can prevent most beaver conflicts by being proactive, and taking the beavers' behavior and needs into consideration when building homes, roads and culverts; or planting landscapes. The goal in preventing and solving conflicts with beaver is to eliminate the need to relocate or kill them, so the integrity of the aquatic/riparian habitat can be maintained in an optimum state for the benefit of the wildlife and land owner. Remember, however, in an optimum state, things are never static. They ebb and flow and change. That's what makes natural areas so vitally alive, interesting, intriguing and wondrous. Beaver are an essential part of that change, that wonder!

And, not to sound trite, but the most effective solution, as it is for most wildlife conflicts, is education. People have all kinds of misconceptions about beaver. For instance, people say things to me like, "If only beaver would eat the Russian olive, or tamarisk." Well, no matter how much we'd like beaver to be relegated to using only the plants we consider noxious, the reality is that beaver eat what they evolved to eat. Beaver have innate characteristics that annoy us: they take down trees, build dams and flood low areas. But remember, beaver are living and working within the parameters of the extremely important and specific niche only they fill so well.

We humans, on the other hand, have the ability to be flexible in our behavior and building practices. Our only limitations are our imagination and inventiveness. It's imperative, when we decide to move to a natural area, that we educate ourselves so we don't ruin and destroy the natural processes and wildlife habitat most of us are moving there to enjoy.

*Giardia lamblia*, a tiny one-celled, parasitic protozoan that causes an infection in the small intestine, is often blamed on beaver, hence the name "beaver fever." There is such a bias that investigators often don't bother looking at any other animals once an infected beaver is found within a water supply. It has been found, however, that animals other than beaver can be a source of *Giardia* cysts. Almost 100% of muskrats, voles, and many wading birds such as herons and egrets are infected, whereas beaver have a prevalence rate of less than 20% for *Giardia*. And it's not just our wildlife that can be a source of *Giardia* water-borne cysts: 30-40% of young calves and lambs can have *Giardia*. You can also get *Giardia* from human pollution. One study (Suk, et al., 1987) found that *Giardia* cysts were found at rates 300% higher in areas used heavily by campers, hikers, hunters and/or anglers, compared to areas with low recreation use. You can also get *Giardia* from swimming pools. You can't blame that on wildlife! Also, poor hygiene and inadequate sanitary conditions account for a high rate of *Giardia* in day care centers, nurseries, restaurants and public institutions. An amazing 10-50% of children in day care, even though they exhibit no symptoms, can be infected with *Giardia*.

Modern filtration systems remove *Giardia* cysts from a water supply. When you're hunting, camping, or hiking, filter or boil drinking water from a creek or lake. Most importantly, wash your hands!

## Reference

Suk, T.J, et al. 1987. The relation between human presence and occurrence of *Giardia* cysts in streams in the Sierra Nevada, California. *Journal of Freshwater Ecology*, 4(1):71-75.



# Let's Do Lunch!

## How to Protect Trees From Beaver



"Beaver are taking down or killing my trees!" That's the most common complaint I hear, and it's one of the easiest conflicts to deal with.

I've actually met people who don't want beaver taking even one of their trees. These people need a lot of enlightening, because they have absolutely no understanding of natural aquatic ecosystem and processes and how they work, or why they're so important. If someone tells you this, take the opportunity: educate them. Let the landowner/manager know that the woody plants beaver prefer, willow family plants (cottonwood, aspen, and willow), have coexisted with beaver for thousands of years. In response to a beaver's partial cutting, these plants resprout. In addition, beaver dams subirrigate and flood riparian areas, expanding the area that supports willow, cottonwood, and aspen.

As well, beaver's preferred summer fare is grasses, forbs, and aquatic plants that can be encouraged by landowners.

### Wrapping large, valuable trees

The goal of wrapping trees is to create a round fence or "tube" of wire that will keep the beaver from reaching the tree.

**NEVER** use chicken wire! Why? For one thing, it's too flimsy. Because it's flimsy, people put it flush against the tree. Then they forget about it. In a few years, the trees are being girdled, and they're dying. I see it happen all the time. It's ironic: people don't want the beaver to use even one tree, but often end up killing the trees in their effort to protect them.

Cut the wire mesh, so it's at least 1 ft. larger than the circumference of the tree you are wrapping.

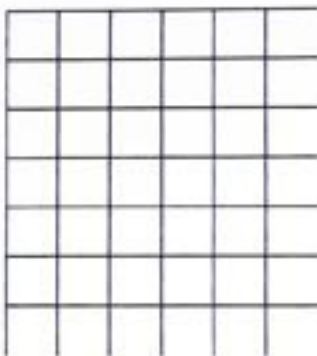

Note: You can also wrap groups of trees.

Cut the bottom horizontal wire off along the bottom, leaving prongs. You can then push the prongs into the dirt, using your foot.

Wrap the tree to a height of 3 ft. if possible. And, leave at least a foot between the tree and the wire, to give the tree room to grow.

Then, bend the loose ends of the welded, using your nipple pipe, around the other side of the wire.

To do the job right, use a heavy gauge, preferably 6-gauge galvanized welded wire. I also prefer welded wire with 4" x 4" squares. Begin by measuring or estimating the circumference of the tree. Then cut a length of the wire long enough to circle the tree and leave a gap of at least 1' between the wire and the tree. Wrap the trees, if possible, to a height of at least 3'. This will hopefully prevent beaver from reaching the trees in the winter when they can get on top of the snow (fun fact: beaver don't hibernate!).

Next, cut the horizontal piece from the bottom of the welded wire, leaving prongs. Make sure that one end of the wire tube has prongs as well. Be sure to leave at least a foot between the wire and the tree, so the tree has room to grow. Place the wire around the tree and close the tube by attaching one side of the wire to the other. Do this by bending the loose ends of the one side around the other side by using a nipple pipe. Anchor the fence/tube to the ground by sticking your foot into the square and pushing the bottom prongs into the ground. This is a lot easier than using rebar to stabilize the wire. This is another reason to use heavy gauge wire: it supports itself.

My second choice of material to wrap trees is 2" x 4" wire mesh or welded wire - again, a heavy gauge. Do the same thing with this wire as you did with the 4" x 4" wire. Of course, you won't have prongs at the bottom; only at the side to connect them. You may need to use rebar with this wire. Or you might want to use large staples around the bottom, so the beaver can't lift the wire, or move it to get to the tree!

Some people have had success with painting trees. To one quart of exterior latex paint, add eight ounces of fine sand (30 mil, 70 mil, or mason sand). Choose a color of paint that matches the tree well. You will need to stir the paint often, so don't make the mixture ahead of time. When painting the tree, use a brush, not a roller, and paint the tree from the ground to about 4' up the trunk. Avoid painting smaller/younger trees that are less than 6' tall because it may harm them.

Note: Regarding conflict solutions to protect trees, I have tried several "taste" aversion methods as well as hot sauce. None of these methods worked very well for me. The beaver, within a week, started chewing on the trees that were treated. These methods might work if you were able to treat the tree once a week. That just seems like a lot of work to me, however.

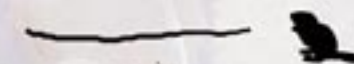





Skip Lisle, Beaver Deceivers International, has spent decades perfecting his flow devices. Skip's flow devices not only work, they are very low maintenance, cost effective, and on top of all that, incredibly aesthetic! After all, one of the last things you want to do, in an effort to solve a conflict with beaver, is ruin a beautiful habitat with something that looks more like refuse than a well-thought out, intelligent solution to a problem.

If you have questions, or want to bring Skip out to demonstrate construction of a flow device:

Skip Lisle

**Beaver Deceivers International**

802-843-1017.

1187 Cabell Rd.

Gafton, VT 05146.

[skiplisle@vermontel.net](mailto:skiplisle@vermontel.net)

## GO WITH THE FLOW

### Beaver Deceivers, Double Filter Systems & Castor Masters

Beaver sometimes plug culverts. Sometimes their ponds grow to the point they may flood an important road or structure. But this doesn't mean the beaver have to be removed. Any of three time-tested structures can be used to effectively and economically work with, rather than against, beaver: the Beaver Deceiver, Double Filter System and Castor Master.

I will describe, and provide photographs of, these three flow control devices. They were originally designed by Skip Lisle of Beaver Deceivers International. It's important to know that flow devices aren't cookie cutter. Once you grasp the basic concept of how they function, you will be better able to build them to fit the dynamics and individuality of the site where they are going to be installed. This is especially true of the Deceiver. The basic shape of a Deceiver is trapezoidal. However, that simple shape can vary greatly, just as the sites where they need to be installed vary. So much of it is judgment call on your part. But, once you've built a few, the idea for the shape or design will start coming to you naturally.

One of the most important things affecting the success of the project is the quality of materials you use. If you try to cut corners, and use something cheaper, it will end up costing you more. And, if the flow device you build isn't performing in a way you think it should, chances are all it needs is a little tweaking to work just fine. That is, unless you've cut corners on the quality of the materials you're using! (A list of materials and where to get them will be provided at the beginning of the section on each flow device.)

As you read through this document, regardless of the flow device you're building, I'll be repeating the mantra: "Looks matter!" When people have problems with beaver plugging a culvert or flooding property, we should do our best to convince them to install a flow device rather than have the beaver killed or relocated. However, if your flow device looks thrown together, and not well built, it matters! It may just be the last flow device you install in the area.

## When Beaver Are Plugging A Culvert, Part 1

# BUILDING A BEAVER DECEIVER

Of all the flow devices, the Beaver Deceiver ("Deceiver") can vary the greatest in its shape. I'm going to show you photos of some of the Deceivers Skip Lisle has built around the country, and I'll give you some basic building instructions. Most of all, I want you to see just how different and unique a Deceiver can be, and how the site helps determine its shape.

### MATERIALS NEEDED FOR A DECEIVER

- 20'x 8' panels of 6 or 4 gauge, 6"x6" wire mesh
- Pressure-treated posts 8' long, 8" diameter, or something comparable
- Pressure-treated 2 x4's to frame the top of the Deceiver
- Outdoor paint for the 2x4's that frame the top of the Deceiver
- Braces (if possible, pressure-treated) for the posts
- Fasteners. Any of a variety of fasteners work well, including long nails, large staples, or carriage bolts

#### Sources for materials:

*I'm familiar with Colorado suppliers for the materials, but they can deliver elsewhere or you can locate construction supply dealers in your state.*

For the wire mesh: Barton Supply (303) 788-9888 or (303) 788-9888; 14800 E. Moncrieff Pl.; Aurora, CO 80011.

For double-walled polyethylene pipes and split band couplers: Timberline Plastics; (303) 289-2557; 6195 Clermont St.; Commerce City, CO 80022.

## BEAVER DECEIVER-TYPE#1 - CONTINUED



FIG. 1-A



FIG. 2-A

Volunteer David Temple stands by on one of the sharpened, pressure-treated posts. Skip has sharpened the post so it looks more like a giant pencil! This makes it a lot easier to pound them into the creek bed.



FIG. 3-A

This shows the edge of the wire mesh that has been cut off to leave prongs on the mesh. That piece is stapled onto the braces to keep beaver from chewing on them.

The first Deceiver I'm going to talk about was installed in September 1999, next to Highway 7 at Longs Peak Inn, near Estes Park, CO. It's your basic trapezoidal shape. Important: Notice the arm coming from the right side of the Deceiver (Fig. 1-A). Highway 7 is heavily traveled with people on their way to visit Rocky Mountain National Park, and thus is a hazard for beaver. The space behind the arm allows beaver to squeeze through and underneath the highway, but is too narrow for them to carry building material and block the culvert! Because the creek flowed more or less straight towards this culvert, Skip decided to build this basic trapezoidal-shaped Deceiver.

1 First, clean the culvert of debris. Then, when you've decided on the shape of the Deceiver you're going to build, start preparing the pressure-treated posts by sharpening their ends to a point like the one volunteer David Temple is standing next to (Fig. 2-A). Of course, if your posts are 2x4's or, 4x4's just make them as sharp as you can.

2 Cut your wire mesh. The Deceiver in the photo is 4.5' high. However, if possible, it's a good idea to push the wire mesh into the creek bottom a bit. So try cutting the wire mesh 5.5', creating prongs at the bottom (see the diagram at the end of this section). drawing Then, while you're attaching the wire mesh to the posts, push the extra foot, if possible, or half-foot into the mud to give the 6 or 4 gauge mesh even more strength.

The piece cut off the mesh to make the prongs is what you then use to beaver-proof the braces.

3 Paint the 2 x 4's that will be used as a rim or rail around the top edge of the Deceiver. You will need exterior grade paint, in a neutral earth color.

4 Cut off the brace ends at a sharp angle, so they can be driven into the mud and support the posts.

5 Using a sledge hammer, pound the posts into the creek bottom, so they're in the outline of the Deceiver you're going to build.

6 Pound the braces into the mud, and connect them to the posts using whatever fasteners you've chosen. Figure 1-A shows how Skip connected to the posts in a real Deceiver. He used a couple braces per post.

7 Also, if you're concerned the beaver may chew on the braces, beaver-proofing is easy! You can see how I did it on the model in Fig. 3-A. It is simply an

## BEAVER DECEIVER-TYPE#1 - CONTINUED

edge cut from the wire mesh and attached using staples. In the photo of the "model" above you can also see there is a floor in the Deceiver (Fig 4-A). This is just an option if the beaver have started digging. I also removed the wire mesh directly in front of the culvert. I can always put it back if there is a problem. But basically, all I did was remove another wall that was catching debris. By the way, this Deceiver has been cleaned only once in ten years!

8 Before you attach the wire mesh to the posts, you need to make sure it's level. You can do this by taking a level, along with a hammer, and where the mesh isn't level, pounding it into the mud until it is. Then use whatever fasteners you've decided on, and fasten the mesh to the posts. If you can't push the mesh into the mud, it's OK; if the beaver start digging, you can put a floor in it (Fig. 4-A). Or you can put a skirt around the Deceiver (Fig 5-A).

9 After you've cut off the posts so they're level with the wire mesh, you are ready to attach the 2x4's to the rim of the Deceiver. Attach the 2x4's by using whatever fasteners you've decided on.

As I said, the Deceiver at Longs Peak Inn near Estes Park CO was installed in September of 1999. It's been cleaned once in ten years. Fig. 1-A shows what it looked like right before it was cleaned. I think it took us all of 15 minutes to clean it!

Remember, beaver are individuals: one beaver may dig, another beaver may not. If they do, it's a simple problem to solve. The point is, when building flow devices and working with beaver, be prepared to respond to changing circumstances or conditions!

Fig. 6-A shows the Deceiver right before we cleaned it in 2007. I asked Skip about the vegetation growing inside of it, but he said it wouldn't affect the Deceiver's ability to perform. So, I didn't bother pulling it out.

Notice the grasses and other debris collected on the part of the wire mesh that's right in front of the culvert. I decided to remove that piece, so debris would just flow through the culvert instead of getting collected on the mesh.

Note: If there's ever a problem with that Deceiver, it would be very easy to replace the piece of wire mesh that was removed.



FIG. 4-A

This model is a replica of a Deceiver that Skip and Wildlife 2000 installed near Estes Park. You can see the beaver using the culvert as a passage way--exactly what is supposed to happen! The arm that extends to the right of the Deceiver allows the beaver to pass under busy Highway 7. It's too narrow, however, for beaver to carry in limbs and block the culvert. A conflict solution is only a success if it works for the wildlife too.



FIG. 5-A

This skirt extends 1 foot from the bottom of the Deceiver. Be sure to leave prongs on the outside of the skirt so they can be bent down and pushed into the mud to help hold the Deceiver in place.



FIG. 6-A

This is the first time the Deceiver above has needed to be cleaned since its installation 7 years before. The only stuff we removed was debris around the bottom. We left the plants growing inside after Skip said they wouldn't interfere with the way the device works. Also, from this angle you can see how debris has collected on the mesh in front of the culvert.

# BEAVER DECEIVER #2



FIG. 7-A

Skip Lisle of Beaver Deceivers International sits by this Deceiver that he just finished building.



FIG. 8-A

Before Skip and Wildlife 2000 installed this Deceiver in 1999, workers at Rocky Mountain National Park were cleaning out the double culvert 3 and 5 times a week at a cost of thousands of dollars! Not only did this Beaver Deceiver stop that problem, it also kept the beaver at the site for the health of the habitat and the enjoyment of people visiting Rocky Mountain National Park. Also, this Beaver Deceiver has never had to be cleaned!

The Deceiver in Fig. 7-A was installed September 1999 at McGraw Ranch in Rocky Mountain National Park. This is one of those situations where something other than the basic trapezoidal shape was needed. First of all, it was a double culvert. And instead of flowing straight into the culvert, the creek (Cow Creek) flowed in from the right. Skip handled this by curving the Deceiver to the right as if it were greeting the water. You will notice by looking at Fig 8-A that the part of the Deceiver in front of the two culverts is wider, but then it narrows a bit, at the upstream end. Skip created a shape that wasn't trapezoidal, but it definitely works!

The Deceiver at McGraw Ranch has always been one of my favorite Deceivers that Skip has built. It's worked flawlessly! As you will notice in Fig. 9-A, there are beaver living right above the Deceiver. And if you cross the road and look downstream, you will see a cascade of beaver dams as far as you can see (Fig 10-A). It's obvious the beaver are thriving at this site, but they're not blocking the culvert! And, to top it off, this Deceiver has never required cleaning.

## - STEP ONE -

You can see clearly in Fig. 11-A just how you create the outline of the Deceiver with the pressure treated posts. You can also see how the braces, sometimes two, support those posts. As you are installing the posts, make sure they are stable, not wobbly! Remember, these devices have to be very strong if they're going to withstand the elements. Please notice how the outline of the Deceiver is curving gently to the right, in the direction Cow Creek is flowing. Skip built this Deceiver to fit into Cow Creek, to be a part of it. When you see it, it's not distracting. That's important to remember. Looks matter!

## - STEP TWO -

After installing the posts, attach your previously-cut wire mesh. As you're doing this, use the level and hammer to make sure the wire is level. Cut the posts so they are even with the wire mesh.

## - STEP THREE -

Finish the Deceiver by attaching the painted 2x4 to the top of the Deceiver. It's good to go!

Important: When the posts were being installed at this site, Skip created a space between the Beaver Deceiver and the culvert: large enough for the beaver to enter, but too small for them to carry in materials and block the culvert. It's the same idea as the Deceiver at Longs Peak Inn. This small space allows beaver safe passage through the culvert, to avoid the hazards of a busy road.

See in Fig. 9-A how the beaver have created a dam above the Deceiver? But wait, there is a cascade of dams on the other side of the road (Fig. 10-A)! The water that's surrounding the Beaver Deceiver is part of the pond that's been created by that dam. This isn't a problem. In fact, this is perfect! The conflict of the beaver blocking the culvert has been solved, but they are still at the site, and have created this beautiful habitat.

Huge trout are swimming among the beaver dams across the road All thanks to the beaver! This is a great selling point for flow devices. After all, beaver are a keystone species, i.e., they maintain a healthy and productive aquatic ecosystem! For example, beaver create wetlands, help prevent soil erosion and promote biodiversity. They also improve water quality and quantity, which provides fish and wildlife habitat while enhancing forage and cover for livestock and wildlife. It's estimated that 85% of wildlife in the West, at some point in their lives, depend on the habitat that beaver create. Now who wouldn't want beaver?



FIG. 9-A



FIG. 10-A



FIG. 11-A

This is what the process of building a Deceiver looks like. Skip builds the skeletons first. Then he puts on the wire

# BEAVER DECEIVER #3

I've included Fig. 12-A to show you a variation in Deceiver design. Skip installed this Deceiver in upstate New York.

It's beautiful in its simplicity (Fig. 13-A). It's also fairly large: The side looks like it's 21 feet!



FIG. 12-A

*This is a Beaver Deceiver Skip installed in upstate New York.*



FIG. 14-A

# BEAVER DECEIVER #4

I don't know when or where Skip installed this Deceiver (Fig. 14-A), but isn't it beautiful? Skip topped it with a deck that can be used for wildlife observation or fishing!

For the record, beaver have never dug under the wire mesh of the flow devices we helped Skip install in 1999.

Remember, flow devices work! If they don't, then they weren't built correctly. However, if there are problems, most of the time all it takes is a little tweaking to fix them. Most importantly, use only quality materials! Take short cuts or use inferior materials, and the flow device will suffer.

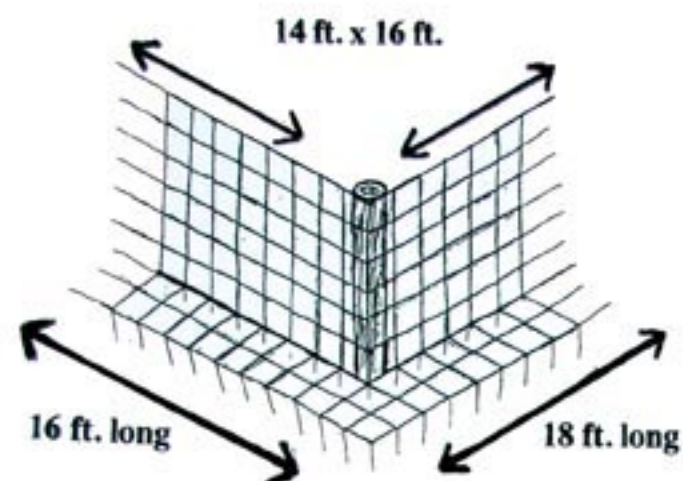

FIG. 13-A

*This is a Beaver Deceiver Skip built in Massachusetts.*

## Putting a Skirt on the Beaver Deceiver

**Fig 15-A** This is one corner of a Beaver Deceiver with a skirt attached.



**Fig 15-A** If the flow device is 14 ft x 16 ft, you would cut the skirt 2 ft. longer: 16 ft. x 18 ft. which means you will be overlapping the ends.

**Fig 15-A** The skirt extends one foot from the bottom of the Beaver Deceiver, and is used as a deterrent if beaver start to dig under the flow device.

**Note:** A skirt doesn't go at the section of the Beaver Deceiver that's in front of the culvert.

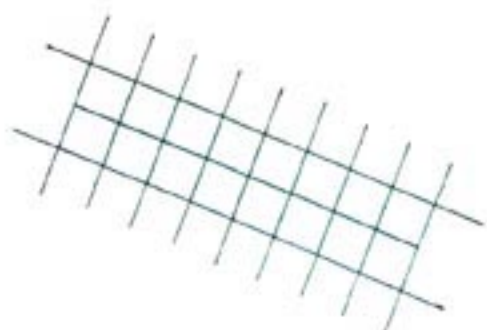

**Fig 16-A** This is just a small section of the skirt to show you what I mean by leaving prongs.

**Fig 17-A** shows how to bend the prongs down. Then you lay the section around the outside of the Beaver Deceiver, and push the section into the bottom of the creek/pond. You could use clips to attach the skirt to the Deceiver if needed, however, Skip didn't use clips when he attached the skirt to the Beaver Deceiver at Longs Peak Inn. But remember, every site is different!

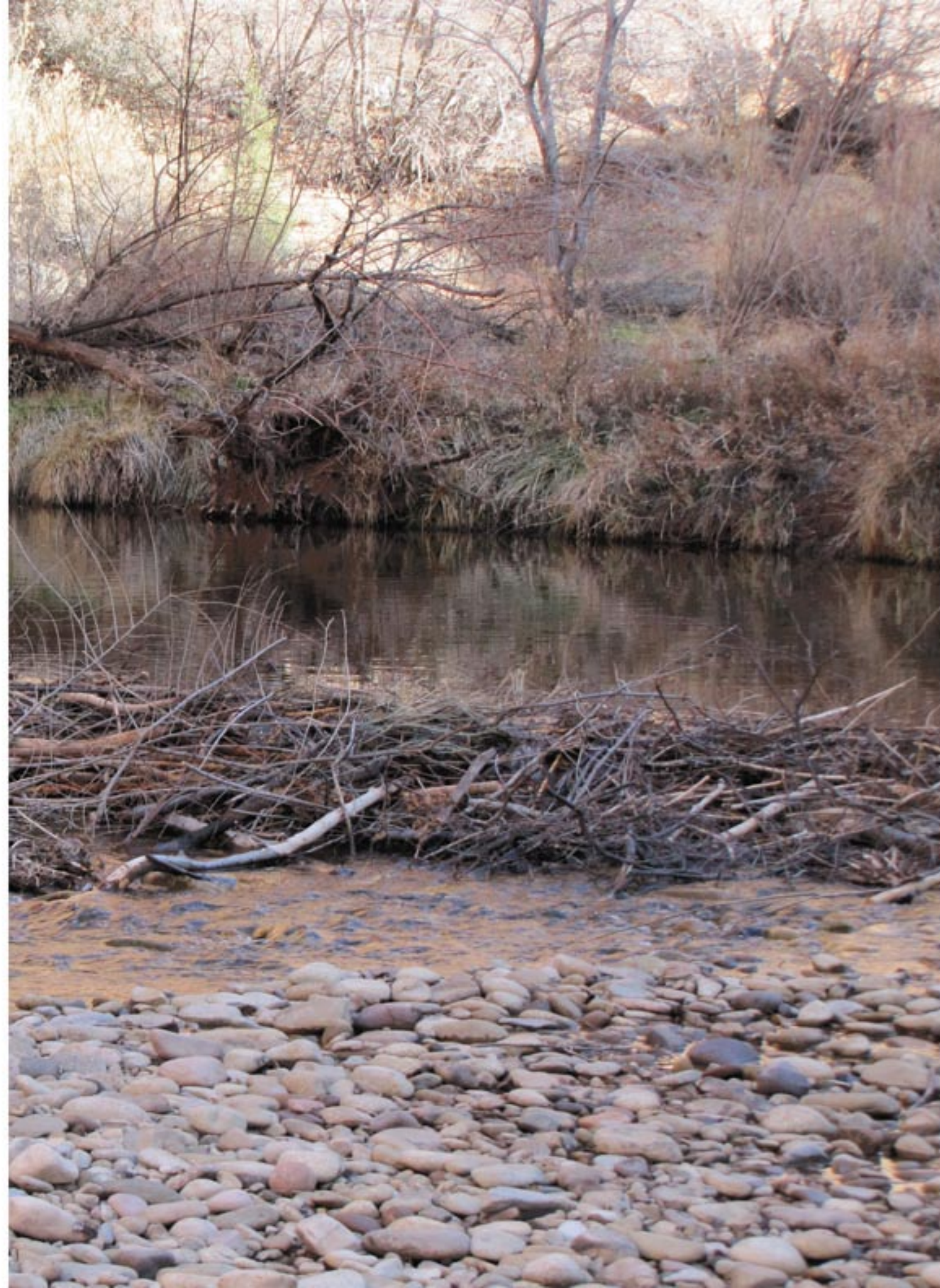
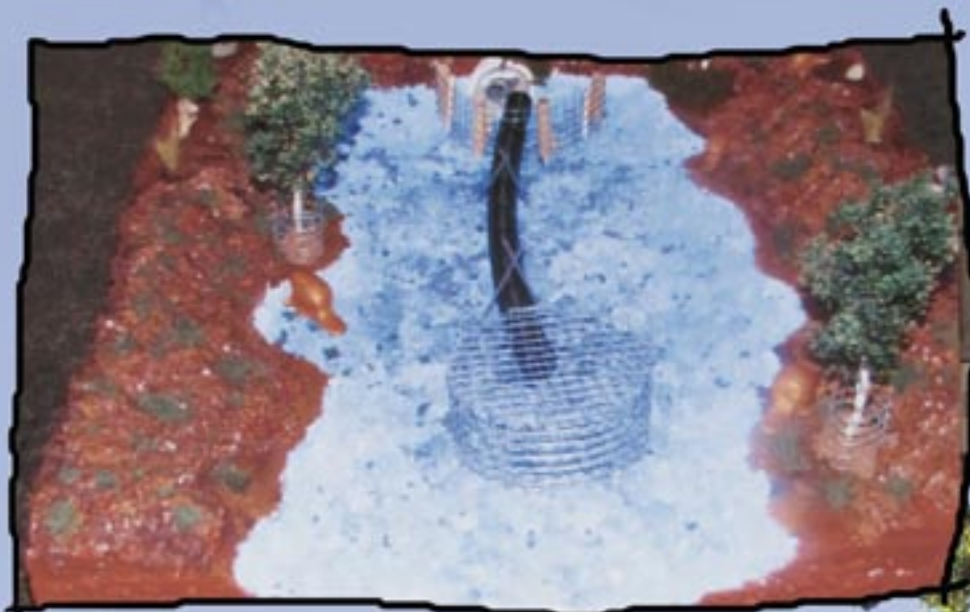

FIG. 1-B



## When Beaver Are Plugging A Culvert, Part 2

# BUILDING A DOUBLE FILTER SYSTEM

The Double Filter System is a second option for preventing beaver from plugging or blocking a culvert, while keeping beaver at the site for the benefit of the aquatic and riparian habitats and wildlife.

Fig. 1-B shows a model of a Double Filter System. The first filter, in the shape of a semicircle, is directly in front of the culvert.

Note: We leave a space on the right or left side, between the filter and the culvert, so beaver can use it as a safe passageway through the culvert. The round filter is connected, using two 20'- long, double-walled polyethylene pipes, to a round filter that is in the shape of a donut without the hole (Fig 1-B). We use two 20'-long double walled polyethylene pipes because it's important to create distance from where the water flows into the pipe, and where it's flowing out of the pipe.

## MATERIALS LIST

- 20' x 8' panels of 6 or 4 gauge 6" x 6" wire mesh
- pressure-treated posts 8' x 8" thick
- braces for the posts
- fasteners

Skip uses a variety of fasteners from long nails, to large staples, to carriage bolts. Use whatever you find works well for you.

- double-walled polyethylene pipes  
Depending on the site, use 12", 10", or 8" diameter.

You will most often need two poly pipes per each double filter system.

- Split-band coupler

Very important: These will make all the difference in the world!

Note: the ties that come with the coupler break easily. I replace them with 36" heavy-duty ties you can pick up at hardware stores. These are a must! I not only replace the ones that come with the coupler, I use two more and run them around the outside of the coupler once it's been used to connect the poly pipes (Fig 2-B). Now you've got something that will last!

- rebar - 7' long x 3/4" diameter

Once they're in place, if they're too long for aesthetics, you can cut them. Or you can use T-posts. I've used both. You use these to keep the poly pipes from floating. I use eight to ten pieces of rebar: two over the double-walled poly pipes at the dam, two immediately in front of the filter, and the rest distributed evenly along the pipe (Fig 3-B).

- thick aluminum wire  
or better yet, epoxy-coated steel wire (which I really like), to tie the rebar or T-posts together.

- 2 48" x 3/16" plain round rod  
that I get at hardware stores to secure the double-walled poly pipes into filters

- pipe nipples 1/4" x 6" long  
These will help when you bend the wire mesh. A MUST!

Sources for materials:

(These are Colorado suppliers, but they can deliver elsewhere or you can locate construction supply dealers in your state)

For the wire mesh:

Barton Supply (303) 788-9888 or (303) 788-9888;  
14800 E. Moncrieff Pl. Aurora CO 80011.

For the polyethylene pipes and split band couplers:

Timberline Plastics; (303) 289-2557;  
6195 Clermont St.; Commerce City, CO 80022.



FIG. 2-B Volunteer Steve Reddy is using the right ties!



Fig. 3-B If you feel you need more, use more, but don't use less rebar

## STEP ONE: PREPARE THE DOUBLE-WALLED POLY PIPE

The double-walled poly pipes are buoyant, but you want them to stay submerged. To solve this problem, you will first need to release the air from the outer rings of the pipe. Using a circular saw, slice the pipe from one end to the other, being very careful to only cut through the rings, not through the inner wall (Fig. 4-B).

*Note:* Do not cut all the way to the very end, and don't cut through the bell at the other end - just right up to it (Fig. 5-B). Then, with your electric drill, drill a hole through the inner wall/groove, between every 6th or 7th ring. When this is done, flip the pipe over and do the exact same thing on the opposite side.

*Note:* 99% of the time you will want to put two 20' long pipes together. So be sure you have split-band couplers.

*Note:* Double-walled poly pipes that are already perforated are available at some suppliers.



FIG.  
4-B



FIG.  
5-B

## STEP TWO: PREPARE THE ROUND FILTER

### -part a.

Start with a 20'x 8' panel of 6- or 4-gauge, 6"x 6" wire mesh. This is the easiest size to work with when building the round filters. The size of the round filter you build will depend on the size of the creek you're putting it in. The largest one I've seen Skip build was 8' diameter. He worked two 2x4's into the top of that filter for added strength. Most of the round filters I've built, or seen Skip build, are 5' or 6' diameter. Also, when building a round filter, remember the mantra: "Looks matter!" You need to get the filters as round as possible (Fig. 6-B). So, below in part d, I'm going to share a couple of tricks I learned from Skip that will help you build a beautiful round filter.



FIG. 6-B

### -part b.

When you decide on the size of your filter, begin by cutting a strip of mesh that will be the wall/band that supports the top and bottom circles of wire mesh (Fig 7-B). The filter should be large enough to keep the beaver far enough from the opening of the pipe that they don't hear or feel water going into the pipe.

*Note:* When making the round filter, make sure the horizontal wire of the mesh faces the outside of the filter. This adds strength to the filter.

Most round filters are 2' or 2 1/2' high. This will be the width of the band. The length of the band you cut will depend on the diameter of the filter you're building. For instance, if you want a filter 6' diameter, you will cut the band 19' long. I always cut it a foot or so longer, and overlap the edges for added strength. Most of the round filters I build are 5' diameter, which means I cut an 18' band. You overlap the ends until you've got the right diameter, then bend the prongs around the opposite side of the wire mesh so they're connected. It's not as hard as it sounds when you're using the pipe nipple!



FIG. 7-B



STEP TWO: PREPARE THE ROUND FILTER (continued)

-part c.

Then you cut pieces of wire mesh for the top and bottom of the filter (Fig 8-B).

*Note:* Be sure to cut these pieces larger so you can have plenty of wire to attach them to the round outer circle you've created.

When you cut the wire mesh for the wall/band of the filter, do not leave prongs except at the ends where you connect the wall/band together to make the circle (Fig. 7-B). Then, when you cut the top/bottom, circles, make sure to cut them larger than the diameter of the band, so you have plenty of material to work with. When you lay the top/bottom onto the wall/band, cut them again, creating the prongs that you will bend around the edge of the wall/band using the nipple pipe.



FIG. 8-B

*This is a pipe nipple. I don't have a clue what it's officially for, but it's perfect for bending wire!*

-part d.

Now, here's the trick that will help you build a "round" filter: As you bend the prongs of the top/bottom around the wall/band using the nipple-pipe, use your free hand to push down really hard on the top/bottom of the wire mesh so it actually bends down, then bend the prongs (Fig.9-B). You should end up with a beautiful round filter (Fig.6-B)!



FIG. 9-B

*Don't be afraid to push really hard. It's the pushing that keeps the filter in a circle!*

-part e.

Now you're ready to create the filter that goes directly in front of the culvert. The shape in Fig. 10-B is the one I like best. Skip used another shape (Fig 11-B) at a site where the creek was very narrow. At this site he also used a metal pipe instead of the double-walled polyethylene. With metal pipes you don't have to use rebar to hold them down. But in most situations they're too heavy to work with



FIG. 10-B

*This is a model, but you get the idea. It's beautiful in its simplicity!*

-part f.

After you've decided on the shape you want, and that's generally something as simple as a partial or half circle, you create the skeletal structure of that filter by using the 8" diameter or 4 x 4" pressure-treated posts.

*Note:* Don't forget to leave a space of 7" to 8" at the side of the filter, large enough to allow the beaver to get into the culvert, but small enough that they can't carry in dam-building material to block the culvert.

STEP TWO: PREPARE THE ROUND FILTER (continued)

-part g.

Attach the braces to the posts using whatever fasteners you've decided on, so the posts have good support.

*Note:* If you cut the end of the braces off at a sharp angle, it will be easier to pound them into the creek bottom.

-part h.

Next, attach the wire mesh to the structure using staples or fasteners.

*Note:* A good all-around height for the filter in front of the culvert is 3'. When it's completed, don't forget to beaver-proof your braces using the edge of the wire mesh.

-part i.

Cut a 1' diameter hole in the middle of this filter, right in front of the culvert, into which you'll eventually fit the poly pipe. *Note:* To discourage beaver from chewing on the braces, see Fig 12-B.

-part j.

Now it's time to fit the poly pipe into the round filter, so you need to cut a hole into the side of the filter. I like to begin cutting the hole 6" (i.e., one square). Continue to cut the rest of the wire upwards, until you have a 1' square hole. Then work the poly pipe into the hole you've made in the filter, so the pipe extends about 6" or 7" into the filter. Make sure the cuts you earlier made into the poly pipe are oriented on the top and bottom of the pipe!

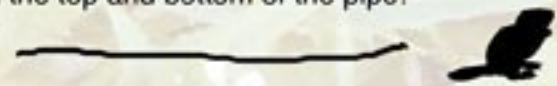

FIG. 11-B

*The round filter which you can barely see in this photo is very small. Because the creek was so narrow, Skip didn't really have a choice. But ideally you want to make the filter large enough that the beaver doesn't hear or feel the water going into the slope.*

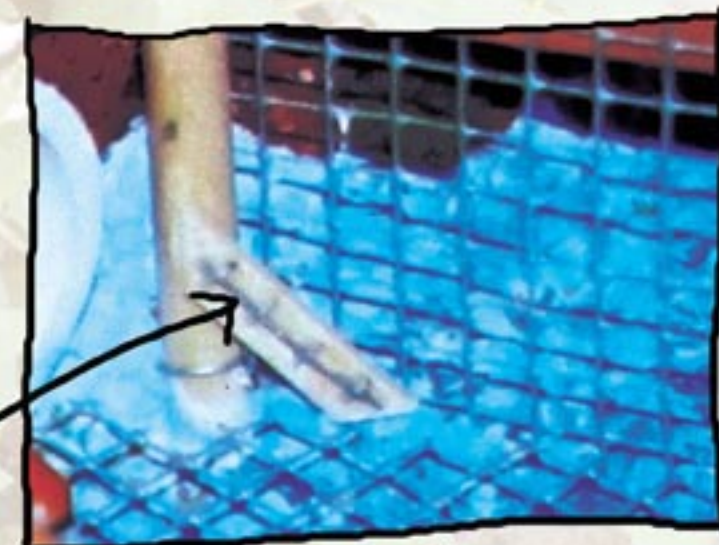
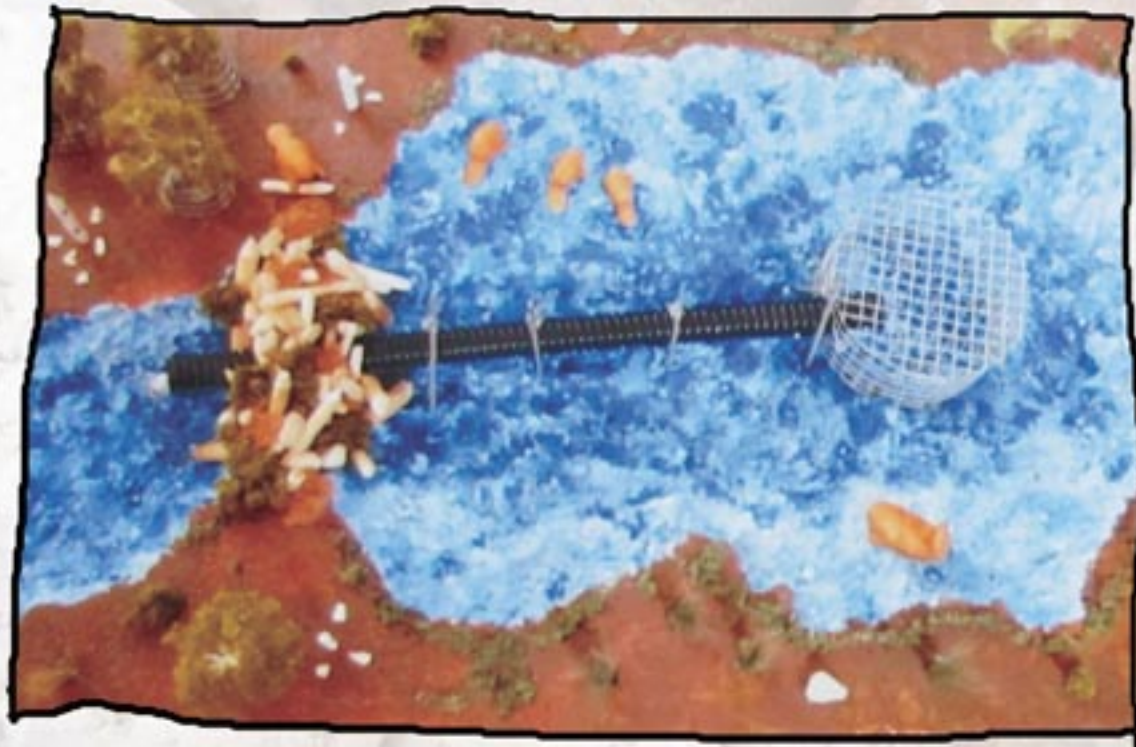

FIG. 12-B

*I hope you can see this, but all we use is an edge cut from the wire mesh: one long wire with lots of cross-wires making little prongs. Then we use staples to attach it to the brace. Works perfectly!*

When A Beaver Pond Is Flooding Property

## BUILDING A CASTOR MASTER



This is the easiest of the three flow devices to build, and is used when a pond is vertically enlarging and threatening to cover critical property (e.g., an essential road).

The Castor Master takes its name from the genus name of North American beaver: *Castor canadensis*. A Castor Master is simply a round filter and two 12", 10", or 8"-diameter double-walled polyethylene pipes (Fig. 1-C).

When people don't understand how the Castor Master works, they think the purpose of the poly pipes is to carry all water coming down the creek. The pipes actually control the vertical growth of the dam, because when beaver start to add to a dam into which a Castor Master has been inserted, they soon quit, because it's not reaping a benefit of deeper water. And don't worry about high water, it will flow right over the top of the dam.

Why use a double-walled polyethylene pipe? The inner wall of the pipe is smooth, as opposed to corrugated. Water flowing through the pipe isn't obstructed in any way, so there's little, if any, noise. The double-walled pipe is also heavier; a big plus!

### MATERIALS LIST

20'x8' panels of 60 or 4 gauge wire mesh

1/4" nipple pipe to help bend the wire mesh

2 double-walled polyethylene pipes

Depending on the site, you use 20' pipes of 12", 10" or 8" diameter. Most of the time, you will need two of the pipes per site. The goal is to create as much distance as possible between the filter, where the water is entering the pipe, and where the water is coming out of the pipe at the dam.

split-band couplers

These will make all the difference in the world!

8-10 pieces of rebar, 7' long, 3/4" diameter

Once the rebar is in place, if they're aesthetically too long, you can cut them. We've used a reciprocating saw to cut the rebar. If for some reason you can't get rebar, you could use T-posts. I've used both. The thing is, rebar just look so much better! The rebar or T-posts keep the poly pipe from floating. I place two rebar over the pipes at the dam, two immediately in front of the filter, and the rest distributed evenly along the pipe.

thick aluminum wire

or better yet if you can get it, epoxy-coated steel wire (which I really like) to tie the rebar, or T-posts together.

one 48" x 3/16" diameter plain round rod

to secure the poly pipe into the round filter. You can get them at hardware stores.

reciprocating saw to cut the rebar

### SUPPLIERS —

I'm familiar with Colorado suppliers, but they can deliver elsewhere or you can locate construction supply dealers in your state.

For the wire mesh: Barton Supply (303) 788-9888 or (303) 788-9888; 14800 E. Moncrieff Pl.; Aurora, CO 80011.

For the double-walled polyethylene pipes, and split band couplers: Timberline Plastics; (303) 289-2557; 6195 Clermont St.; Commerce City, CO 80022.

# BUILDING A CASTOR MASTER, CONTINUED

## STEP ONE

### Prepare the double-walled poly pipe

**a** The double-walled poly pipes are buoyant but you want them to stay submerged. To solve this problem, you first need to release the air from the outer rings of the pipe. Using a circular saw, slice the pipe from one end to the other, being careful to only cut through the rings, not through the inner wall! Also, stop short of cutting all the way to the end of the pipe (Fig. 2-C).

**b** Next, make another slice measuring about 2" from the first one, slicing from one end of the pipe to the other. Then, take your electric drill and drill a hole through the inner wall/groove, between every 6th or 7th ring. When this is done, flip the pipe over and do the exact same thing on the opposite side.

*Note:* 99% of the time you will want to put two 20' long pipes together. So, be sure you have split band couplers. Double-walled poly pipes that are already perforated are available at some suppliers.



FIG. 2-C

## STEP TWO

### Prepare the round filter

**a** Start with a panel of 6 or 4 gauge, 6" x 6" wire mesh. The panels you're looking for measure 20' x 8'. This is the easiest size to work with when building the round filters. The size of the round filter you build will depend on the size of the creek. The largest one I've seen Skip build, was 8' diameter. He worked two 2x4's into the top of that filter for added strength. Most of the round filters I've built, or seen Skip build, are 5' or 6' diameter. Also, when building a round filter, remember the mantra: LOOKS matter! You need to get them as round as possible. So, I'm going to share a couple of tricks that will help you build a beautiful round filter (Fig. 3-C)..

**b** When you decide on the size of your filter, begin by cutting a strip of mesh that will be the wall/band that supports the top and bottom circles of wire mesh. The filter should be large enough to keep the beaver far enough from the opening of the pipe that the beaver don't hear or feel the water going into the pipe.

*Note:* When making the round filter out of wire mesh, make sure the horizontal wire of the mesh is on the outside circumference of the filter. This adds strength to the filter.



FIG. 3-C

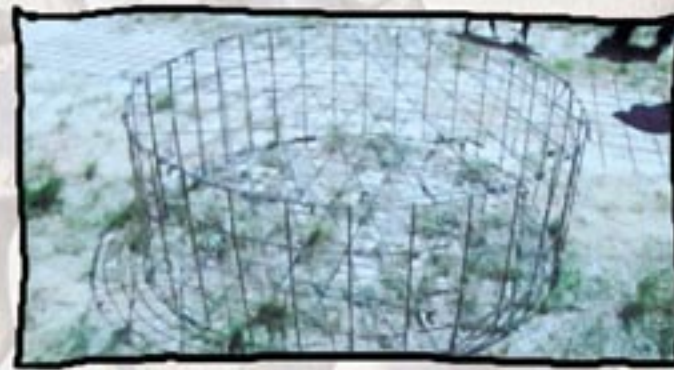

FIG. 4-C

**c** Now, here's one of the keys to building a "round" filter (Fig. 4-C). When you cut the wire mesh for the wall/band of the filter, do not leave prongs. Then, when you cut the top/bottom, circles, make sure to cut them larger than the diameter of the band, so you have plenty of material to work with. When you lay the top/bottom onto the wall/band, cut them again, creating the prongs that you will bend around the edge of the wall/band using the nipple pipe.

*Note:* Fig. 5-C shows how to attach the top/bottom to the wall/band without distorting the circle. As you bend the prongs of the top/bottom around the wall/band using the nipple-pipe, use your free hand to push down really hard on the top/bottom of the wire mesh so it actually bends down, then bend the prongs (Fig. 6-C). Make sure the top and bottom are connected really well!

**d** Now, it's time to fit the poly pipe into the round filter, so you need to cut a hole into the side of the filter. I like to begin cutting the hole 6" (one square) from the bottom of the filter. Continue to cut the rest of the wire upwards, until you have a 1' square hole. Then, work the poly pipe into the hole you've made in the filter, so the pipe extends about 6" or 7" into the filter. Make sure the cuts you've made into the poly pipe are on the top and bottom of the pipe!

**e** Now it's time to use the 48 "x3/16" plain round rod to secure the poly pipe to the filter. Near the top of the pipe, drill two holes into the rings of the pipe, right across from each other (Fig. 7-C). The goal is to be able to push the round rod into one of the holes, and out the hole across from it. Next, wrap the ends of the rod around the wire mesh of the filter, so it's really secure in the filter. Again, make sure the cuts you've made in the pipe are on the top and bottom of the poly pipe.

**f** You're almost ready to take the Castor Master into the water. But first, you have to prepare the beaver dam. You do this by removing a small portion of the dam, like a pocket, into which to nestle the double-walled poly pipe.

*Note:* The placement of the poly pipe in the dam is very important! It's the placement of the pipe in the dam that helps to control the vertical growth of the dam, therefore the water level behind the dam. Also: As you remove the sticks from the dam, lay them aside. You will need them later.



FIG. 5-C



FIG. 6-C



FIG. 7-C

g. Now, take the filter and pipe out into the water (Fig. 8-C). This is usually a two-person job because a 5' or 6' diameter filter, with a poly pipe attached into it, can be heavy. When you take the filter out into the creek, be careful not to loosen or pull the pipe out of the filter (Fig. 9-C). As you set the filter in the creek bed, manipulate it, so the poly pipe not only fits into the pocket you've created in the dam, but extends about 3' over the top of the dam on the down-stream side (Fig. 10-C).



FIG. 8-C

Attention: Before you use the rebar to stabilize/hold the poly pipe in place and ensure it doesn't float, make sure the cuts you've made in the pipe are on the top and bottom.

h. Take one set of rebar, or T-posts, and criss-cross them over the top of the poly pipe right on top of the dam. Make sure to pound them into the dam really well. You may have to move the end of the rebar around in the sticks of the dam to find the right spot, so you can get them really anchored and holding.



FIG. 9-C

i. Now, take the material you've removed from the dam and replace it over the top of the pipe/dam.

j. Then, take a long piece of the epoxy-coated steel or aluminum wire, and wire the two rebar together.

k. Do the same thing, creating rebar "X's", with two more pieces of rebar or T-posts in four more locations: (1) between the beaver dam and where the two pipes are connected; (2) where the pipes are connected; (3) at the middle of the pipe; and (4) between the connection site and round filter. Remember, really get those rebar or T-posts secure in the bottom of the creek! If you feel you need to use more rebar to hold the poly pipe, go ahead. Don't use less, however.



FIG. 10-C

l. The Castor Master is almost finished! All you have to do is trim the rebar, so they look neat and even. Looks matter!

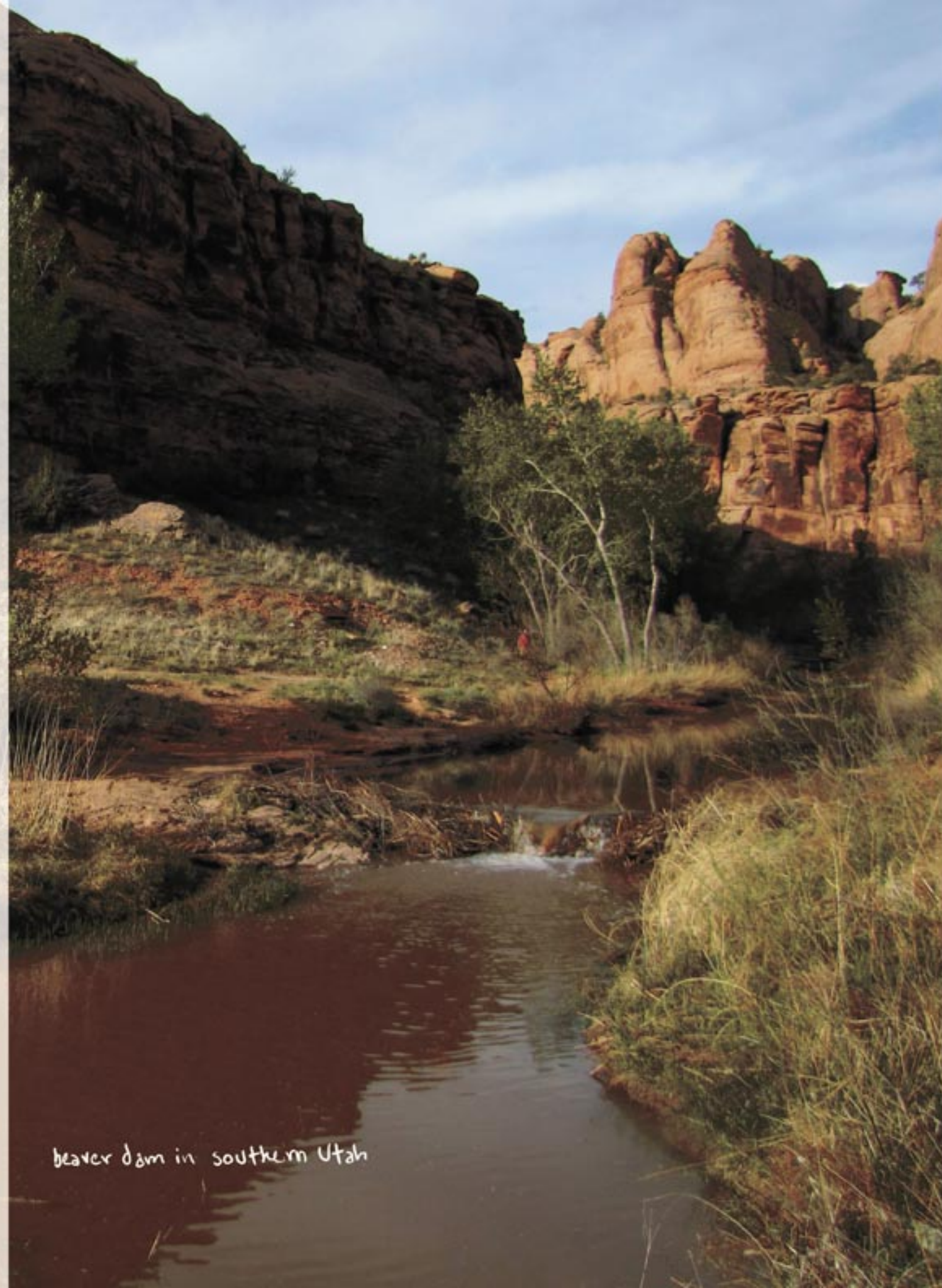

beaver dam in southern Utah

# Living With Beaver

## Changing the Minds of Landowners

When people found out there was someone in Colorado who was live-trapping and relocating beaver rather than killing them, lots of people who wanted their beaver relocated started calling me. It didn't take long however, once I realized how important beaver are to the health of the aquatic and riparian ecosystems, to understand that before I remove this keystone species, I should first try to encourage people to coexist with the beaver.

It's no secret, I love beaver! I also have a very deep appreciation and respect for what they do for the habitat and other wildlife, their water storage abilities – the list goes on and on. But, I also love to tell people all about beaver and what they do. Maybe it's my enthusiasm that changes the minds of the folks calling me. I like to think what changes their minds are the things I'm telling them about beaver and how they are benefiting by keeping the beaver on their property.

Often I get a call from someone who thinks they want beaver removed from their property. I start out by telling them all the ways beaver benefit the habitat. But . . . I also tell them about beaver. Believe me, the "awe" factor is very helpful! Things like: beaver mate for life and are monogamous, how the males share

equally in the rearing of the kits, and how the kits stay with their families for two years. And how the size of the family is basically determined by the availability of food. Facts like that are very helpful and most people are amazed. Below, I've given you some ideas on how to proceed with landowners who are experiencing conflicts with beaver.

First of all, never take for granted that the landowner you're working with knows anything about beaver. Too often, landowner information about beaver comes from someone promoting the tradition of lethal management for their own gain, or from people who hear, and continue to pass on, false and/or negative information. Both instances lack understanding of and/or care for the integrity of the ecosystem and lead people to choose management options that are at best nothing more than a band-aid approach.

### Goal #1: When talking to a landowner or manager, the first goal should be to keep the beaver in their current habitat.

To do this, I generally start out by talking about the benefits beaver provide for the habitat, other wildlife, and even livestock and, therefore, the landowner! It also helps to have some of this information written down and handy, to give to the landowner so they can read it at their leisure. (Note: Wildlife 2000 has

a brochure called "Beaver: Nuisance or Opportunity?" If you don't want to write something yourself, you can order that brochure from Wildlife 2000. Similarly, the Wildlife Conservation Society has recently prepared an attractive brochure ("Pond of Gold") illustrating the multiple benefits of beaver.

The following is just some of the information you can use to help change the minds of people who are unaware of the value of beaver:

Beaver are a keystone or foundation species, i.e., in suitable habitat, they are key to maintaining healthy aquatic and riparian ecosystems and an abundance of many other species.

Beaver create wetlands, help prevent soil erosion, promote biodiversity and improve water quality and quantity. Their work provides habitat for fish and wildlife while enhancing forage and cover for livestock and wildlife. For instance, it's estimated that 85% of wildlife in the West, at some point in their lives, depend on the riparian habitat that beaver create.

A network of beaver dams can help reduce high flows and downstream flooding.

The water beaver store in their ponds by building dams is just the water you can see. What you can't see, is all the water stored beneath the pond, and in the banks, because of the sponge effect. This water then creates water flows that last longer in the summer.

Water quality is improved when the rich soil and sediment, which would otherwise wash downstream, instead settles to the bottom of the pond and is trapped behind the dam. This in turn heals incised streams and causes the water table to rise and floodwaters to spread out over the land, which recharges aquifers and helps a variety and abundance of plant life to flourish.





## BEAVER FACTS

Also, at the same time you're promoting the benefits of beaver, don't forget to talk about the beaver themselves. You can never underestimate the awe factor! As you're talking about the benefits, throw in some information about the beaver themselves.



Beaver are monogamous, mating for life, but will take another mate if the first one dies. Their families are considered relatively stable, with the oldest female (matriarch) being the central organizing member of the colony. When the matriarch dies, the colony generally breaks up and reorganizes elsewhere.



Beaver reach sexual maturity at one and a half to two years old. They have one litter a year and, in Colorado, beaver mate in January/February. Gestation is about 105 days, with kits being born sometime in May.



Kits nurse about six weeks. However, four to 14 days after the kits are born, they start eating tender shoots and leaves, often brought to them by their father! Once kits are weaned, all family members take part in raising them. Kits generally stay with their parents for two years before they leave home to find a mate and create a colony of their own.



When kits are born, they weigh a few ounces, their eyes are open, and they are fully furred. The average litter size is two to four kits, but can reach six if the food availability is good. Note: When food is abundant, beaver have larger litters!



Kits nurse about six weeks. However, four to fourteen days after the kits are born, they start eating tender shoots and leaves, brought to them, most often, by their father! Once kits are weaned, all family members take part in raising them. Kits generally stay with their parents for two years before they leave home to find a mate and create a colony of their own.

When beaver are removed from good habitat, they're simply leaving a void that other beaver will move in and fill. Beaver work hard to build a home, they struggle to survive, and care for their families. They have a life and a purpose. To view them as disposable is not a wise way to consider a fellow creature.

During your conversation, start to discuss the many solutions available to make coexisting easier, so beaver can stay in the habitat!



Conflicts? . . . Never doubt that education helps!

### Conflict 1: Beaver are taking down trees

This is the most common complaint I hear. It's also one of the easiest conflicts to solve! In the section, "Let's Do Lunch," you learn how to correctly wrap trees. Also included is a recipe for painting trees with sand and paint if you would like to try that method.

First, let the landowner know that beaver and trees, particularly trees of the willow family (willow, cottonwood, aspen) have evolved together over thousands of years. As ponds expand, so does the riparian area in which willow and cottonwood thrive. In fact, I've heard beaver called "willow farmers!" To successfully coexist, Wildlife 2000 recommends that only large, aesthetically valuable trees be wrapped/protected, allowing the beaver access to the smaller trees.

The following information should make the landowner happy: Once beaver have their dams and lodges completed, their tree felling activity should slow down. They will still take, or prune, some willows, cottonwood, and aspen. They do this for two primary reasons: (1) to wear keep their ever-growing teeth sharp (i.e., softer dentin lies behind the harder front enamel of their teeth); (2) to make repairs to the dams and lodges; and, (3) in the fall when they gather a food cache that can remain fresh throughout winter, since they don't hibernate. But in the summer, much of their focus will be on aquatic plants and roots, forbs, grasses, and even algae.

**ALERT!!** Be aware of the dreaded Golf Course Mentality! People who exhibit this condition don't like change. They prefer the sterile look of a golf course. This condition, if it goes untreated, brings a halt to most natural processes! It's the bane, not only of wildlife, but of the people who care about wildlife and healthy, functioning ecosystems. The good news is, people who exhibit this condition may not even know they have it, so with education they usually can be healed!

### Conflict 2: Beaver are plugging a culvert, causing a road to flood.

There are a couple of ways to solve this dilemma: The Beaver Deceiver and the Double Filter System. Please see the sections on those devices. If these devices are built correctly, they can last a long time: 15, maybe even 20 years.

Perhaps the most important factor affecting the success of building any of the flow devices is the quality of materials. If you think you can get by on the cheap, think again! Also, remember the mantra: Looks matter. When the flow devices last, and

## RESOLVING CONFLICTS

they're great looking, you will be called again and again for your services.

To learn how to build a flow device, you can contact Skip Lisle of Beaver Deceivers International; (802) 843-1017. No one is better at building these flow devices than Skip! No one!

The landowner may be concerned about cleaning flow devices. Good news: They require very little cleaning. One device, installed near Rocky Mountain National Park in 1999, has only been cleaned twice in ten years! Another Beaver Deceiver was installed the same year at McGraw Ranch in Rocky Mountain National Park. It's working flawlessly and has never needed cleaning in ten years! The point is, these devices work if installed correctly, and require little maintenance.

### Conflict 3: A beaver dam is causing the flooding of private property, or a road.

For this situation, you will need to install a "Castor Master," which is relatively easy to build. You can find a description of how to build one in this booklet.

This conflict happens when people build in a floodplain. People are unaware, or choose to ignore, that floodplains are supposed to flood, and benefit from flooding! Along with talking about how the Castor Master works, use this opportunity with the client to enlighten them about the importance of preserving functioning floodplains.

Let the landowner/manager know that the Castor Master is a much better solution than simply sticking a PVC pipe through a beaver dam. For years, people have been sticking small, perforated PVC pipes through a beaver dam and calling them a flow device. When these fail, the landowner tells anyone who will listen that flow devices don't work. Not true - if built correctly, flow devices are a great, inexpensive solution to help regulate water levels. Explain to the landowner/manager, that the Castor Master is created by using easily-obtained building materials. And it can be built and installed by two people in less than a day!

Note: If these conflict solutions won't do the job, and the beaver have to be removed, please read the section, "When Beaver Don't Get to Stay Where They Are."



# When Beaver Don't Get To Stay Where They Are

## LIVE-TRAPPING AND RELOCATING BEAVER



*For the record, I've been  
live-trapping and relocating  
beaver since 1985.*

According to the Letter of Authority issued to me by the Colorado Division of Wildlife, my live-trapping season starts June 1st and ends September 1st, unless relocation sites are in the eastern plains (i.e., <math><9,000'</math>). In Colorado, beaver have their kits sometime in May, so you won't see the kits out swimming around until the second or third week in June. Because I always do my best to capture the whole family so they can be relocated together, I don't start live-trapping until the third week in June. I will put this information later in the piece.

In order to give the beaver time to build a lodge (their shelter) and create a food cache for winter, it's important, if the relocation site is above nine thousand feet, to stop live-trapping by September 1st. But if I have a relocation site on the Eastern plains, I can live-trap and relocate beaver until September 1st. If we were to have an early winter, I would stop

live-trapping before September 1st! When live-trapping and relocating beaver, consideration of the beaver and their life schedule is what will make you a successful live-trapper.

Note: The only trap I will use or recommend is the Hancock live beaver trap (Fig. 1-D).

Hancock Trap Co.  
P.O. Box 268  
Custer, SD  
hancocktrapco@goldenwest.net

The Hancock live beaver trap, if set correctly, is the most reliable trap if you want to catch beaver without harming them.

If the Hancock live-trap is new, the first thing you need to do is soak it in a creek or lake for 24 hours to remove all the oils and human scent from the live-trap while it was being made.



FIG. 1-D A Hancock Trap

## materials

In addition to the Hancock trap, I have found the following materials work the best for successfully live-trapping beaver:

- $\frac{1}{8}$ " vinyl-coated cable

I like pieces that measure approximately nine feet long. This is a good length because you never know if the site where you're setting the live-trap will have a high, steep bank. You can always shorten the length by using cable clamps (see below). Note: Some people prefer using chain instead of cable. I find it is harder to work with and makes the live-trap heavier.

- rebar 2.5' long,  $\frac{3}{4}$ " diameter

- nut wrench

- 2 cable clamps

Two cable clamps for each live-trap (Fig 2-D). Use the cable clamps and cable to make a loop attached to the live-trap (Fig 3-D). I leave a loop I can attach to the other side of the trap so it's easier to carry when not in use (Fig - 4-D). Make another loop at the opposite end of the cable (Fig. 2-D).

Note: Make sure to check the tightness of the cable clamps throughout the season; they can loosen with time.



FIG. 2-D Cable Clamp



FIG. 3-D Cable loop



FIG. 4-D carrying handle

Looking at the Hancock live-trap, you have two sides: one that is a chain link basket that can expand, and the other that is flat and made of wire. I'm going to call the flat side the "back" of the trap.

Set the Hancock correctly! I make a joke about this when I do presentations. I say, "I learned how to set the Hancock Live Beaver Trap because I'm a woman, and not a man, and so I didn't throw away the instructions that came with the trap!"

This always gets a laugh, but it's so true! After the presentations, I meet biologists, animal control officers, whoever, who tell me they never knew the correct way to set the Hancock live-trap, and now they're looking forward to using it. So, don't pass over this section!



FIG. 5-D



FIG. 9-D



FIG. 6-D



FIG. 10-D

## How To Set A Hancock Live-Trap

Chris Gasser and Dick Northrup demonstrate how to set the Hancock live-trap:

1. With the V-bar at the base of the trap relaxed, put the chain link basket side of the trap down, and rest the V-bar on your thigh. Then put the rings over the turn buckles (Figs. 5-D and 6-D). This will hold the live-trap open.

2. Now, flip the trap over so the chain link basket side is up, and stand on the V-bar (Fig 7-D).

3. Bend over, grab the jaw of the chain link side of the live-trap, put your thumbs on the hook/latches and push up (Fig 8-D). With the help of your body weight, pull the trap open (Fig 9-D). Then while holding the trap open with your knees, make sure the pan safety and trigger bar and dog are all in an open position (Fig 10-D).

4. Now, lift the jaw of the live-trap until it's about 6 inches from the V-bar. Take the short trigger bar, the one attached to the middle of the V-bar, and hold it up so you can stick it between one of the squares in the chain link fence, about the second row. Now you can push the chain link basket down so it's as flat as possible against the V-bar. Take the middle trigger completely over the jaw, and fit it into the notch so it looks like Fig 11-D.

5. Important! Make sure the bar is straight. If it's not, do it again.

6. Once the bar is straight, take the long trigger bar and close it over the top of the short trigger bar (Fig 12-D). But don't stand up, or let go of it yet!!

7. While you're holding the long trigger bar in that position with your right or left hand, whichever you're more comfortable with, reach up and hold down the bar that's near the pan (Fig 13-D). Once you're holding this bar down, you can release the other hand, and put the safety ring on the bar.

Now the Hancock live-trap is ready to bait, and put into place!



FIG. 7-D



FIG. 11-D



FIG. 12-D



FIG. 8-D



FIG. 13-D

The number of live-traps you set depends on the site. You don't want to set so many live-traps they're right next to each other. When I'm trying to catch a family, I've never set more than four or five live-traps. But, I've rarely set less than two if I believe there is a single or a pair. The other consideration is how many beaver in live-traps you can fit comfortably in your vehicle.

Note: I set my live-traps late in the afternoon or early evening, and I pull them the next morning, regardless of whether or not there's a beaver in them. Never leave a beaver in the trap. Never!

It is especially important to pull empty live traps in urban areas. If you leave a live-trap out, there's a chance you could catch a dog or hurt a curious child. Or the live-trap could be stolen! It's also not good for the traps. I've seen Hancock live-traps that people regularly leave in the water, and they're nothing but rust buckets. Some of my Hancock traps are 25 years old and they're in good shape. I may have had springs replaced in some of them, maybe a pan, but that's all - they're not rusted out!

I use both bait and scent. Using bait is especially important if you're going to be catching kits because they need to eat, and eat often! It's also nice for the adults to have something to munch on. I feel this is just being considerate of the wildlife you're catching. The bait I use is fresh, green, small diameter limbs, of whatever the beaver are eating in the area: most often that's willow. I thread them through the wire on the back of the trap, with all the butts of the branches towards the pan (Fig. 14-D). The limbs should be in the shape of a fan. I have found the fan shape makes it easier to hide the jaws of the trap. When live-trapping in an urban area, it's essential to camouflage the trap from public view.

I also use "traditional" beaver lure for scent. As for the scent placement, the pan should be 2" below the water line. The lure/scent goes on the butt of one of the branches, about 2" above the water line. But wait: before you put the scent on, wash the live-trap off in order to remove your human scent.



FIG. 14-D



# Installing a Hancock Live-Trap

**1. First rinse off the live-trap. Then position the trap** so the pan is 2" below the water line. Since I work with a volunteer, I hold the live-trap in place and they pound in the rebar so it's in a straight line from the eye on the back of the trap. They then fix the cable and clamps. (I've set live-traps by myself but it's a bit more work.)

Note: Unless the water is so deep it's over my head, I get in the water with the trap. It's just easier for me to set it that way. While I'm in the water adjusting the trap and making sure there's nothing to interfere with its closing, the volunteer is on the bank, ready to pound the rebar into the ground. From my position, I can see just where to do that, so the cable will be at a straight line, not at an angle, from the trap to the rebar. Before you take the safety off, put a dab of beaver lure 2" above the water line, on one of the butts of a branch you're using for bait.

**2. Next, take the safety off!** First, put the dog under the lip of the pan, and hold it in place with your right hand. Slip the safety off the trigger bar and slowly release your right hand. You will feel the resistance and know it's OK to release the pan. It's pretty much common sense. In the beginning, if it makes you uneasy, or until you get the hang of it, you can rest your foot on the jaw of the live-trap. Actually, when people ask me to teach them how to set the live-trap, I want them to do this by feel. Sometimes the water can be so silty you can't see what you're doing, so I like them to learn to take the safety off blind-folded. Maybe 2 or 3 times in 25 years I've had the trap slam on me and it can make a pretty good bruise. For me that's not a big deal. You just have to take a deep breath, relax and take your time until you get used to this wonderful trap. It is truly a wonderful live-trap, but it's big and powerful, so it's important to pay attention!

**3. When you're placing the rebar,** make sure it's the shortest possible distance from the eye located on the back of the live-trap where the cable is connected. Also, make sure you pound the 2 1/2" x 3/4" diameter rebar far enough into the ground so it doesn't wobble and will hold the live-trap in place with a big beaver in it.

**4. Adjust and fasten the cable.** Loosen the screws on the cable clamp, and slip the cable over the rebar. Then, adjust the cable so the pan on the live-trap is 2" below the water line. Pull the cable so there's absolutely NO slack! Then retighten the cable clamps.

**5. This is a good habit to get into: always check and recheck the cable clamps.** If you put the cable high on the rebar, make the cable loop so small that it won't slip down on the rebar. If you're putting the loop of the cable flush against the ground, there's no need to make the loop so tight.

The depth of the water and height or steepness of the bank will be the deciding factors of where you put the cable on the rebar. Sometimes you can put it over the rebar with a large loop and flush against the ground. However if the water is deep, and the bank not very high, put the cable high on the rebar, and make the loop very small and "tight" on the rebar so the cable won't slip down on the rebar. This way, if you catch a big beaver, the cable will keep the trap with a beaver in it from slipping down into the water and drowning the beaver! In some places, I've also attached the cable to a tree or the limb of a tree, if there's one handy. If you do this, you should always test it by putting all your weight on the limb to make sure it can hold a live-trap with a beaver in it. I'll talk about variations of this later.



FIG. 16-D

trap set



FIG. 17-D

trap set



FIG. 15-D

trap successful!



FIG. 18-D

2 beaver in a trap



FIG. 19-D

trap on a bank

Note: Setting the Hancock live-trap near a beaver slide or feeding station can be a good choice. But with the Hancock trap, there are many more options! As long as the "Always" and "Never" rules are followed, you're jammin!

Because it's so much easier to show you trap sets rather than explain them, I've included photos below as examples of places I like to set my traps (Figs 20-D-23-D). If you still have questions about what you see, call me: Tippi (303) 935-4995.



FIG. 20-D



FIG. 21-D



FIG. 22-D



FIG. 23-D

Most important: You should always try to live-trap the whole family, so they can be relocated together. I've been live-trapping and relocating beaver so long, I just know. But, if I have any doubts, I will set live-traps until I don't catch anymore beaver.

It is only ethical to trap the entire family, since beaver are monogamous, mating for life. We should try to disrupt their families as little as possible because they're already being taken away from their home. Never relocate kits without an adult! Another positive when you relocate families together: they're more apt to stay where you relocate them.

## The Dos and Don'ts of Live-Trapping

### ALWAYS

The following actions should be second nature. Do them!

- Always make sure the back of the Hancock trap has support, so when it closes, the beaver won't be under water.
- Always make sure there is the shortest possible distance between the eye on the back of the trap, where you've connected the cable, and the rebar. Don't put the rebar at an angle to the live-trap.
- Always make sure there is absolutely NO slack in the cable.
- Always double check the cable clamps to make sure they're tight.
- Always make sure nothing interferes with the closing of the live-trap. Before you take the safety off, check by running your hand around the outside of the trap that's under water. If there are any roots, or limbs, cut them off.
- Always check traps the morning after they're set, so the beaver are in the live-trap the shortest possible time.
- Always try to catch the whole family so they can be relocated together. This may take a few days.

### NEVER

- Never put a Hancock live-trap in the break of a dam!
- Never lay the Hancock trap down in the water.
- Never set the Hancock trap completely under water. The Hancock live-trap hangs in place; it doesn't matter how deep the water is or how steep the bank is.
- Never relocate beaver so early in the year that you miss catching the whole family and leave some behind, and never too late in the year that they don't have time to build a shelter and create a food cache for winter!



If the water is really shallow where you want to place your trap, dig out a place at the bottom of the creek in which to set the live-trap. I usually have a small shovel with me just for this purpose; just make sure the trap fits close to the creek bank.

Since 1985, I've trapped nearly 1,000 beavers. Only two adult beaver have died, and that was because of flash flooding! Now if it's going to rain more than a sprinkle, I won't set the live-traps! Creeks are supposed to meander, but many creeks have been straightened so that they look like an irrigation ditch, and this contributes to flash flooding.

Also, unfortunately, a few kits died because they got caught in the jaws of the live-traps. This is always heartbreaking, but unavoidable. When kits leave the lodge in the spring, they hang out together

and explore their new world. When they come upon a live-trap, one will trigger it, but not everyone makes it into the trap before it closes! I have, however, caught four kits in the live-trap and everyone was just fine. Once I caught an adult male and three kits, and once I caught three geese! Everyone was fine!

I've caught eight beaver in two days setting three traps the first night, and four the second night. You generally catch males, kits and yearling first, then the females. But nothing is carved in stone! You may catch females the first night you set your live-traps. People have to get over trying to set rules. There are no rules. I've been live-trapping and relocating beaver so many years, I just know when I've got the whole family. When I have doubts, I set live-traps a couple more nights until they continue to be empty.

# After You Trap Beaver



FIG. 24-D



FIG. 25-D

## Getting Beaver Out Of the Trap

When you approach the beaver in the live-trap, talk softly to them. That's right - talk to the beaver. I'm not kidding! Let them know they're going to be OK. Sometimes you'll have a beaver who will butt his/her head against the trap. Talking to beaver helps calm them down. Most beaver aren't real aggressive. I've met more beaver who will try to push me than bite me (I've been bitten only once in 25 years). Just remember, the way they act depends a whole lot on how you treat them!

As you pick up the live-trap, continue to talk softly to the beaver. Be careful, but in all the years I've been catching beaver, I've never had one try to bite my fingers while carrying the live-trap. However, and this is important - NEVER, NO NEVER drag the live-trap with a beaver in it! The beaver can lose its toenails and fingernails!

No matter how you're transporting the beaver back to where you're going to hold them until you can get the rest of the family, make sure they're not in the sun. In fact, while the beaver are in your care, it's imperative to keep them cool and well-ventilated! I can't stress this enough: it's so important to keep the beaver cool. And don't cover them with a tarp. While they're in the sun, I've seen it done! With the body heat of the beaver and the sun on the tarp, it will become a sauna. Please, at all times, think about what you're doing, think about the animals in your care, and... use common sense!

## Keeping Beaver Alive Until You Can Trap the Whole Family

Holding beaver while you're trying to capture the rest of the family isn't that difficult, but it's a lot of work. You have to make sure they're fed, watered, cleaned, which means I simply remove old branches, poop, etc., and, very important, keep them cool! But as far as the holding facility, it's not elaborate. I've been keeping beaver this way since 1985 (Figs. 24-D, 25-D). It's always worked for me in the places I'm living. If you can build something better, branches, for instance with a pond, that would be great!

I have collapsible cages (3' x 2.5') that I can attach together, so the beaver have more room if needed. If I get a large family, for instance six, eight, or more beaver, I put three cages together. Watch the beaver; you can tell if an animal is too crowded or otherwise stressed. If they are stressed or anxious for any reason, use good judgment and just fix it! I also have large, 12 inch diameter stainless steel pans of water for the beaver to drink from. The kits sometimes get into the pans and sometimes the adult beaver turn the pans over (Fig 24-D). That's what I mean by lots of work. It seems I'm forever filling up the pans with water. On warm days, even though the beaver can get under the tarp that partially covers their cage (Fig 25-D) and they're under the shade of a tree, I still squirt them lightly with cold water to make sure they don't get too warm. Again, here you have to use good judgment, you don't want to drown them, they need to be able to get dry, just

make sure they're cool. I feed them in the evening with branches, mostly snap willow (*Salix fragilis*) I collect from a creek near my home. I stick lots of branches into the cages. I just use good judgment, and the beaver never go hungry. When it's a large family, I will have so many branches in a cage they can hardly move. By the next morning, what's not eaten will be on the floor for me to remove. That's OK; I feel it gives them something to do at night: chew on the branches.

Sometimes I let the beaver out to wander around my back yard. And I have a little kid's pool that I put the kits in for a change of pace. Regarding holding times, I try to relocate the beaver as soon as possible. The longest I've kept a beaver family was six days. This happened three times, because heavy rains prevented me from trapping while I was trying to catch the whole family. I think it's harder on me than it is on them! I love the beaver, but catching them and relocating them as soon as possible is better for everyone.

## Moving a Beaver from the Live-Trap into a Transport Cage

First, put the Hancock trap in front of the cage, making sure the back (flat side) of the live-trap is towards the cage and the V-bar is pointed up.

Now slip the rings over the turnbuckle to release the V-bar, and the V-bar will fold over the basket side of the live-trap. Lower the opening at the bottom of the live-trap towards the opening of the cage, so the beaver can see there's a way out. When you do this, again, talk softly to the beaver, encouraging them into the cage. Most of the time they will walk right into the cage. Once in awhile, it will take longer. These are times you have to be patient.

Once beaver are in the cages, cover half of the cage - only half - with a tarp. Also, make sure the cages are never in the sun.

## Moving Beaver to a Relocation Site

(See the section, "Finding Good Sites for Beaver" about finding a relocation site.)

Wildlife 2000 has never lost a beaver while relocating them! I've heard of beaver being relocated with four out of six beaver dying because they were allowed to get too hot. That's right, it's that simple. To relocate beaver successfully, don't let them get too hot!

The first couple of vehicles I used for live-trapping didn't have air conditioning. Now remember what I said before? "Think about what you're doing, think about the animals in your care, and... use common

sense!" I wouldn't take a dog on a long trip, in hot weather, in a car without air conditioning! So, to keep the beaver cool, I buy bags of ice. I poke three holes in each bag with a car key. Using a bungee cord, I attach the ice to the top of the cage. Each cage gets its own bag of ice. The cold water slowly drips on the beaver, not enough so it's real annoying to them, but enough to keep them cool. I now have a vehicle that has air conditioning, but I still use ice!

I've had people with pickup trucks offer to help me by donating the use of their pickup for relocating beaver. I always decline. I prefer beaver being inside the vehicle with me. I don't want them in the hot sun in the back of a pickup! However, once we're near the relocation site, if the last part of the trip is really rugged, we have put beaver in the pickups of District Wildlife managers who support what we are doing and are willing to help. But beaver are in the pickup for only a short time. In that situation, I leave the tarp on the top of the cages, so the sides are open and there's still a lot of ventilation! The bags of ice, if there is any ice left in them, go on top of the cages, underneath the tarp.

If all you have is a pickup truck, be sure to cover the beaver so the sun doesn't beat down on the beaver. You will also need to cover one side, so the wind doesn't blast them. Make sure they have lots of ventilation, and you should still use bags of ice! If there are kits, or it's a long trip for yearlings and adults, offer them some nice, fresh, green branches to munch on.

## IMPORTANT: Beaver families go together

This drives me absolutely crazy! You'll get a call from a landowner, who wants beaver. Then, when they check with the state wildlife manager, they're told they can have four beaver. It's like they think they're ordering beaver from a catalogue! I'm quick to let them know, it doesn't work that way. If I catch a family of five or six, that's what they get. I would never, for instance, kill two beaver, if I get a family of six, because the wildlife agent says they can only have four! It's Live-trapping and Relocating Beaver Ethics 101: beaver families go together.



# Finding Good Sites for Beaver



**What should you ask a landowner who wants beaver relocated to their property?**

*Note: My experience is with Colorado. Different states will have different regulations regarding beaver relocation.*

According to my Letter of Authority issued by the Colorado Division of Wildlife, the District Wildlife Manager has to approve the site to which I relocate beaver. I generally leave getting that approval up to the landowner. I also ask the landowner to make sure his or her neighbors are OK with beaver being relocated to their property. I really care about the animals, and wouldn't put the beaver someplace where they would just be hurt, or killed.

I've been live-trapping and relocating beaver for such a long time, that, thank goodness, a lot of people who want beaver have heard of me and they call Wildlife 2000. And when people call the Colorado Division of Wildlife, either wanting beaver relocated from or to their property, some of the Division staff will give out Wildlife 2000's number. Of course it helps to develop a good relationship with your wildlife managing agency, to be able to call and ask if they have any places where beaver could be relocated.

If you're a trapper in the traditional sense, you may already have a good working relationship with your wildlife agency. Build on that, because what you're going to be doing now is in a different direction! You want to move landowners away from looking at beaver as "nuisance" and therefore disposable. You're going to be involved in a lot of education, helping people expand their wildlife values.

You want to know how they hope to benefit from having beaver relocated to their property. Do they want restored habitat? Increased bio-diversity? Expanded riparian area? Wetlands creation? Reversal of soil erosion? Flood control? Creation or enhancement of habitat for other wildlife? Improved flood control?

**What's the water situation?** Find out if the place you're moving the beaver to is a lake/pond, or a small or large creek.

**How deep is the creek?** If the creek is shallow, say, a couple of inches, then when the beaver are released, there is always the chance they may hit the water and split, looking for the deeper water they need for protection from predators. To hopefully prevent this, I often ask the landowner if they would mind digging out a place in the creek that's anywhere from 2.5'-3' deep, and 8'-10' in diameter. Once the little human-made pond fills, I like to leave a large bundle of supplementary food, preferably willow, at the site, then release the beaver about fifty feet upstream from the prepared site. I stand in the water so the beaver are more or less forced to travel downstream. I'm hoping the beaver will find the site with the food, and set up house. That's what I hope, but all beaver are different!

The shelter

beaver lodge in Quebec



of the pond, with provided food, may be what it takes to encourage beaver, or beaver family, to stay where they're relocated.

If it's a lake/pond, it's a great place to relocate a beaver with kits. The kits will have an easier time in the slow-moving water. The same is true for a larger creek. If it's a gentle running creek, families will work.

On the other hand, it would be preferable to relocate adult beaver to a large creek that has swift running water. I do realize, however, that when you're live-trapping and relocating what some people consider a nuisance beaver, you don't always have control over the size of the beaver family you're moving. You just have to take the beaver into consideration and do the best you can.

If a couple miles of stream are available, I like to put in another family, or at least a pair of beavers, not long after the first beaver are relocated.

**What type of food is available?** A site with lots of willow near the water is perfect! Beaver are sometimes called willow farmers, because often beaver can't keep ahead of the riparian expansion they foster! Aspen and cottonwood also work. But sometimes, food is simply not sufficient at a site. It's hard to believe, but I've had landowners tell me they had an absolutely perfect, wonderful place for the beaver, and when we got there, there was nothing for them to eat!

Wildlife 2000 tries to fit the beaver to the site. Ideally you should have several sites available to relocate beaver. Some places are just nicer, will take less work to get a habitat started. Maybe there's a lot more willows close to the water, and

maybe the water is moving a little slower. I like to put beaver with kits in such sites.

I'll put adult beaver in a site that's more marginal, for instance there's an incised streambank and it's going to need more work to turn into something beautiful. In situations like this, you can also leave food with the beaver, to help them get started. Just put large bundles of willow or aspen along the creek, partially in the water, and the beaver will use them.

Don't forget genetic diversity! When Wildlife 2000 relocates beaver into habitat extensive enough to hold more than one family, I like to relocate a second adult pair, or a pair with one or two kits, or just yearlings and no kits, at a later date.

But be careful! Avoid relocating beaver to a site already occupied by an established family. Beaver are very territorial. If you have an established family, there will be problems!

**If you're a live-trapper, remember to:**

1. Develop a good working relationship with your state wildlife managing agency and federal agencies.
2. Foster word of mouth of your work from landowner to landowner, manager to manager.
3. Take out an ad in a local newspaper touting the benefits of beaver and indicating that you can live-trap and relocate beaver. And if someone has problems with beaver, let people know you're available to wrap trees and install flow devices.

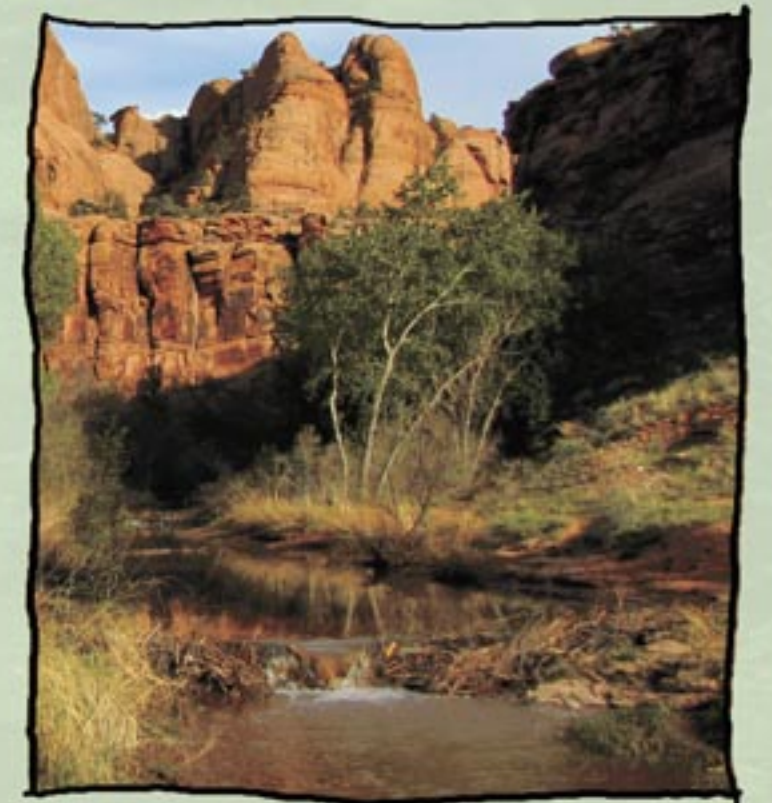

## Live-Trapping

**1. You have a lot on your plate but think you also have time to catch a few beaver.**

Make sure you have time to do the job correctly. For example, if you have a lot on your mind, you won't check and recheck the cable clamps to make sure they're tight and won't slip, and that there is no slack in the cable. You might fail to make sure the live-trap will function correctly when it catches a beaver.

**2. You think the beaver will be OK in the live-trap a day or two!**

Unless you're in a car wreck and die, you check your traps for beaver the following morning! Never, no NEVER - leave a beaver in the trap! No excuses!!

**3. It's March, or maybe October and someone has called, wanting you to relocate beaver. You decide to go ahead and do it.**

No, no, no! The time of year is everything. To make sure I don't leave kits behind, I don't start live-trapping until the second or even the third week in June. In the Fall, I usually stop relocating by September 1st to give the beaver time to build a lodge/shelter and create a food cache for winter. However, if I have a relocation site below 9,000 ft., I can relocate beaver until the 15th of September.

So how do you get the land owner to wait until it's the right time of year? Provide a little beaver education to develop some appreciation of the animals. Not just about all the good things beaver do in the environment, but also about the beaver themselves. And, it's always possible to jury-rig a solution until the beaver can be live-trapped and relocated safely.

**4. It's going to rain, but only a little. I'll set traps anyway.**

Watch the weather! If more than a sprinkle is predicted, don't set live-traps.

## Flow Devices

**1. Using light gauge or flimsy wire**

You're dealing with the elements: ice, high water! You're not going to find what works at your local hardware store. For the right supplies, look at the beginning of each flow device section in this booklet. If you try to cut cost by buying materials that are that aren't quality, you will end up paying for it anyway in the end!

**2. Building the flow device in a rush**

Take your time so you will do a good job. While you're building it, remember to make it work for the beaver and other wildlife too.

## Wrapping Trees

**1. Let's get by with chicken wire.**

The problem is, chicken wire is very flimsy and has to be placed flush against the tree. This means it's easy to forget about, and you might girdle the tree and kill it. I recommend 4"x 4" heavy gauge or 6 gauge welded wire. If you can't find that, 2" x 4" heavy gauge welded wire will do. When you wrap the tree, leave at least a foot between the tree and the wire to give the tree room to grow.

## Holding Beaver While You're Collecting the Family

**1. They're animals; I can stick them anywhere as long as they're in a cage.**

Wrong! Beaver overheat so easily. Keep them in the shade, never in the sun. And, you will still want to partially cover (but only half of) the cage with a tarp so the beaver can feel secure. They will also need fresh water at all times. And freshly-cut limbs to eat. Feed the beaver in the late afternoon around 3:00 pm. Also, offer them an apple maybe once a day. Be sure to cut them in half so the beaver can smell them. Some beaver really like them!

## Relocating beaver

**1. I'll just put them in the back of the pickup truck. They will be in the wind, and that will keep them cool.**

Never no never, leave beaver with the sun beating down on them! Again, they are so sensitive to heat. Also, the wind in the back of a pickup truck would be very stressful to the beaver. However, when you put something over the caged beaver, be sure to leave the sides open so the beaver will be well ventilated. To be doubly cautious, use ice! Poke three holes in each bag so the water slowly drips on the beaver.

**2. Kits are with their parents, they will be fine. I don't need to do anything extra for them.**

If you have kits, make sure to give them fresh branches while you're relocating them. All babies need to eat often.

# Mistakes to Avoid

These are some of the most common mistakes I see people make while learning how to live better with beaver



## Conclusion

In this publication, Sherri Tippie has shared her advice gleaned from 25 years of working for beaver, who in turn work for many others.

As she has urged you, please do contact her ("Tippie") with any questions you have, or to arrange for a (delightful) workshop about working with and live-trapping beaver, taught by Sherri : (303) 935-4995.

If you have a technical question about building water flow control devices, or would like such a device built for your agency, town, or property, consider phoning Skip Lisle at (802) 843-1017.

Grand Canyon Trust, which has partnered with Sherri Tippie to complete this booklet, is working to restore beaver to the three national forests of southern Utah. We would be glad to converse with you about the successes (or failures!) you're (and/or we're) experiencing at maintaining the presence of beaver in their habitat, or restoring beaver to their former habitat:

Mary O'Brien, [maryobrien10@gmail.com](mailto:maryobrien10@gmail.com), [www.grandcanyontrust.org](http://www.grandcanyontrust.org)

### Some special Tippie reminders:

Looks matter! (if you're a water flow control device)

Take care for beaver family values: Keep trapping beaver until you're sure you've caught the family group

At all times, think what beaver need – when you're building a Castor Master or Beaver Deceiver; and when you're livetrapping, transporting, or translocating them.

Most importantly, remember to enjoy one of the best wild partners we have.  
We certainly are in need of partners in taking care of this world!

**WORKING WITH BEAVER**  
FOR BETTER HABITAT NATURALLY

BY SHERRI TIPPIE  
WILDLIFE 2000

JUNE 2010